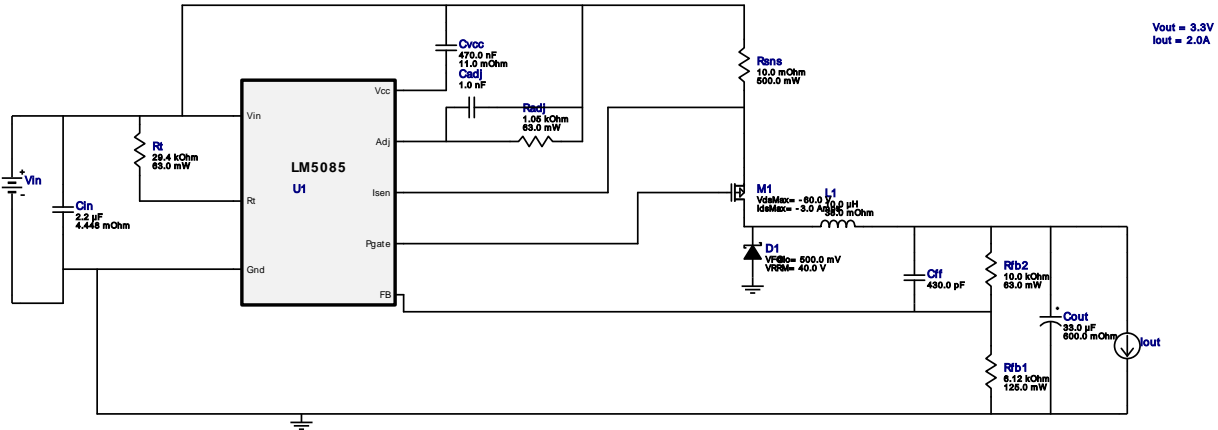
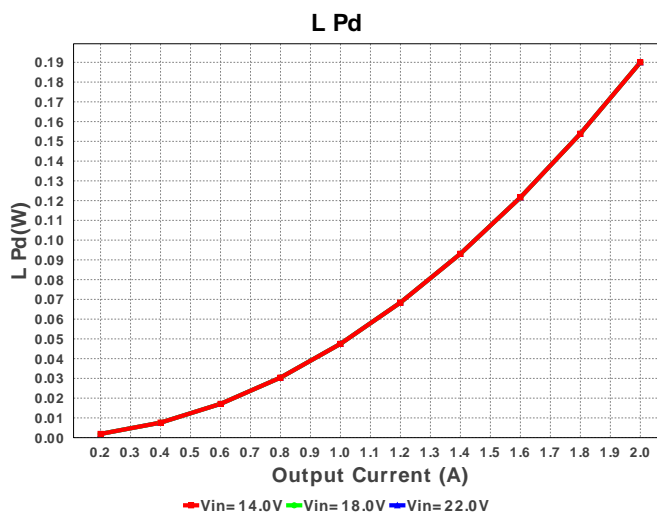
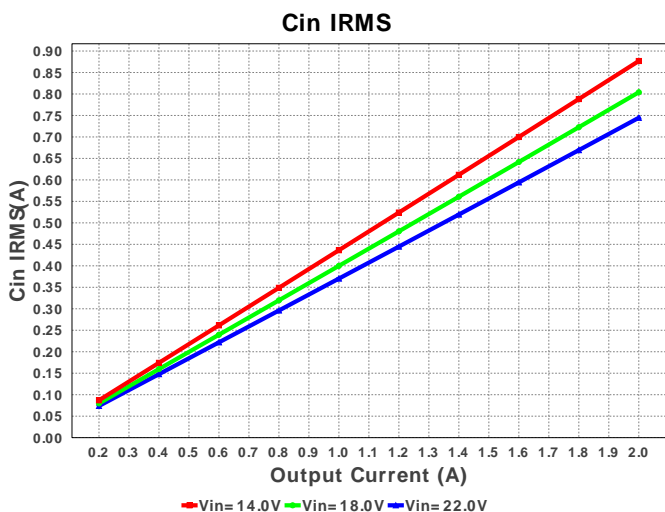
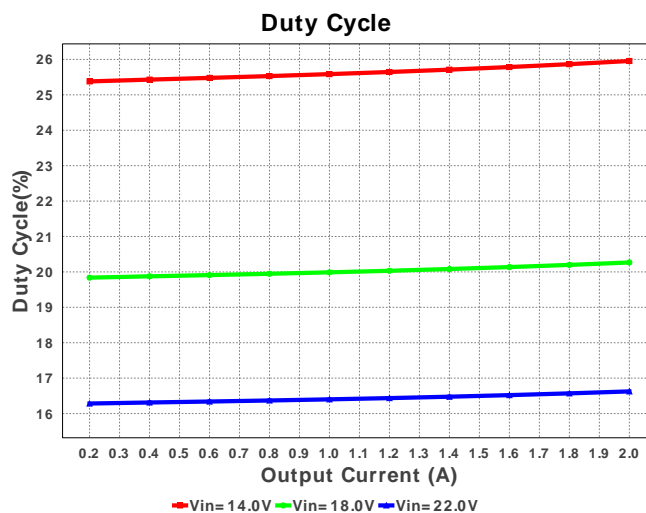
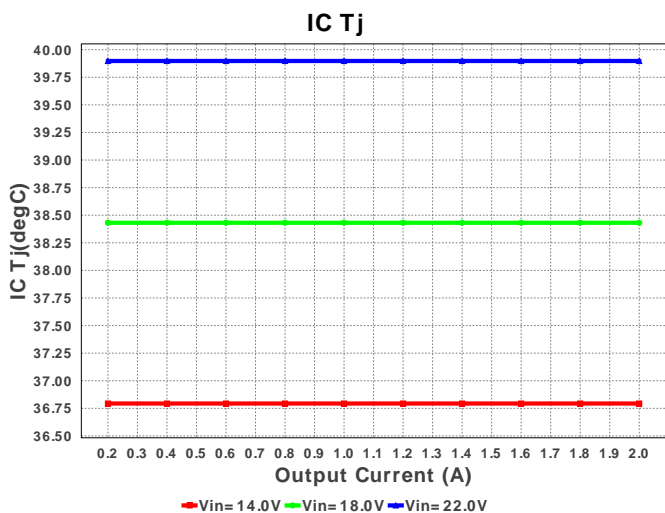

**WEBENCH® Design Report**

 Design : 4792288/6 LM5085MY/NOPB  
 LM5085MY/NOPB 14.0V-22.0V to 3.30V @ 2.0A

**Electrical BOM**

#	Name	Manufacturer	Part Number	Properties	Qty	Price	Footprint
1.	Cadj	Samsung Electro-Mechanics	CL21C102JBCNFNC Series= C0G/NP0	Cap= 1.0 nF VDC= 50.0 V IRMS= 0.0 A	1	\$0.01	0805 7 mm <sup>2</sup>
2.	Cff	MuRata	GRM1555C1H431GA01D Series= C0G/NP0	Cap= 430.0 pF VDC= 50.0 V IRMS= 0.0 A	1	\$0.02	0402 3 mm <sup>2</sup>
3.	Cin	MuRata	GRM31CR71H225KA88L Series= X7R	Cap= 2.2 uF ESR= 4.448 mOhm VDC= 50.0 V IRMS= 2.2252 A	1	\$0.05	1206_190 11 mm <sup>2</sup>
4.	Cout	AVX	TPSA336K006R0600 Series= TPS	Cap= 33.0 uF ESR= 600.0 mOhm VDC= 6.3 V IRMS= 318.0 mA	1	\$0.13	3216-18 11 mm <sup>2</sup>
5.	Cvcc	AVX	0805YC474KAT2A Series= X7R	Cap= 470.0 nF ESR= 11.0 mOhm VDC= 16.0 V IRMS= 0.0 A	1	\$0.02	0805 7 mm <sup>2</sup>
6.	D1	Diodes Inc.	B340A-13-F	VF@Io= 500.0 mV VRRM= 40.0 V	1	\$0.11	SMA 37 mm <sup>2</sup>
7.	L1	TDK	VLP8040T-100M	L= 10.0 uH DCR= 38.0 mOhm	1	\$0.22	VLP8040 113 mm <sup>2</sup>
8.	M1	Fairchild Semiconductor	FDC5614P	VdsMax= -60.0 V IdsMax= -3.0 Amps	1	\$0.23	SOT-23-6 15 mm <sup>2</sup>
9.	Radj	Vishay-Dale	CRCW04021K05FKED Series= CRCW..e3	Res= 1.05 kOhm Power= 63.0 mW Tolerance= 1.0%	1	\$0.01	0402 3 mm <sup>2</sup>
10.	Rfb1	Yageo America	RT0805BRD076K12L Series= RT0805	Res= 6.12 kOhm Power= 125.0 mW Tolerance= 0.1%	1	\$0.05	0805 7 mm <sup>2</sup>

#	Name	Manufacturer	Part Number	Properties	Qty	Price	Footprint
11.	Rfb2	Vishay-Dale	CRCW040210K0FKED Series= CRCW..e3	Res= 10.0 kOhm Power= 63.0 mW Tolerance= 1.0%	1	\$0.01	0402 3 mm <sup>2</sup>
12.	Rsns	Stackpole Electronics Inc	CSR1206FK10L0 Series= ?	Res= 10.0 mOhm Power= 500.0 mW Tolerance= 1.0%	1	\$0.11	1206 11 mm <sup>2</sup>
13.	Rt	Vishay-Dale	CRCW040229K4FKED Series= CRCW..e3	Res= 29.4 kOhm Power= 63.0 mW Tolerance= 1.0%	1	\$0.01	0402 3 mm <sup>2</sup>
14.	U1	Texas Instruments	LM5085MY/NOPB	Switcher	1	\$0.85	MUY08A 24 mm <sup>2</sup>

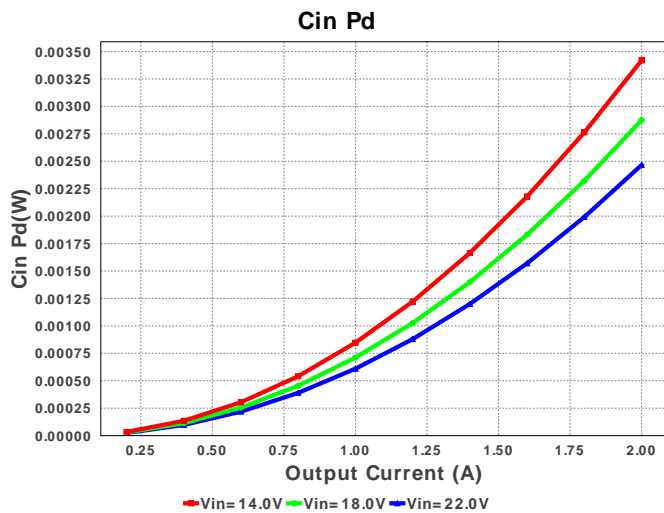
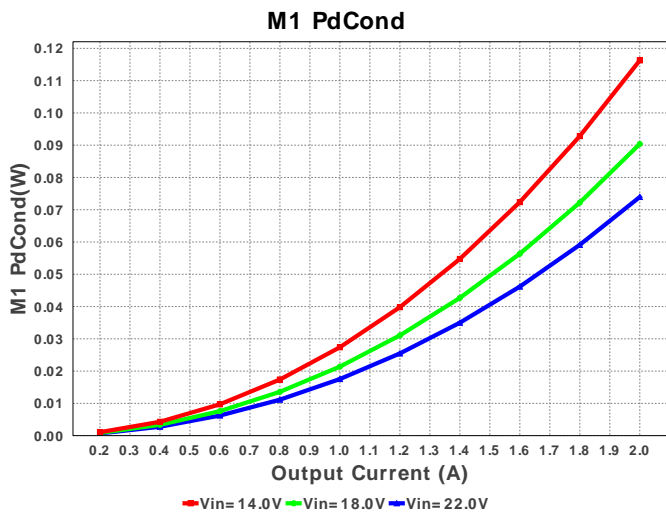
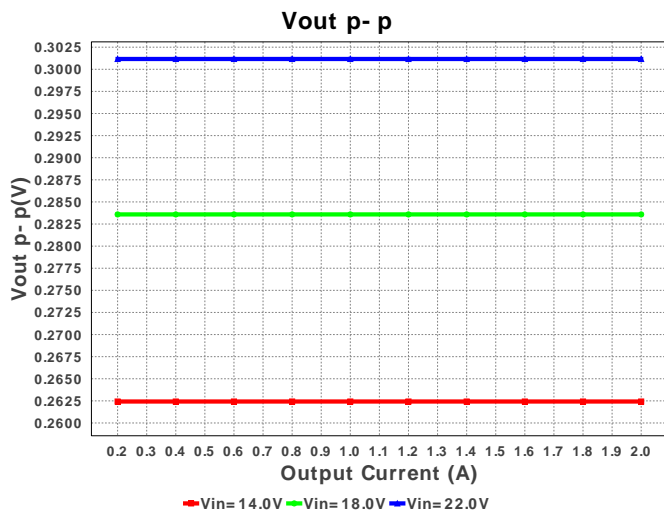
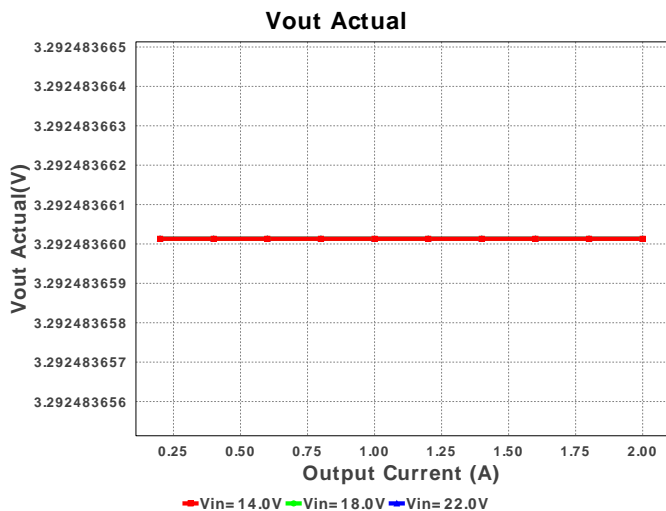
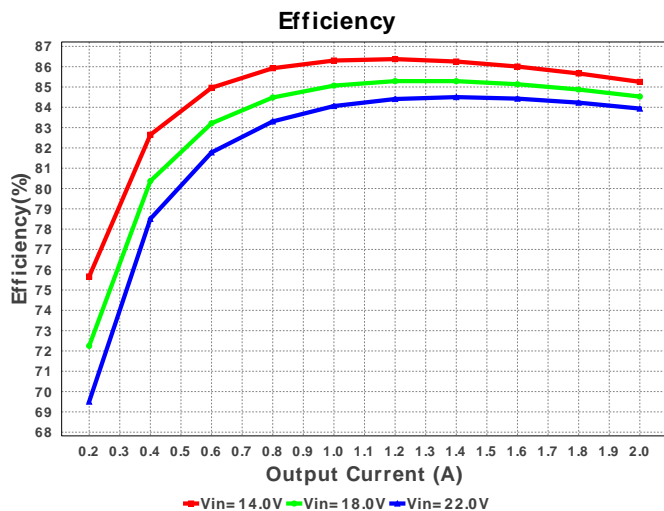
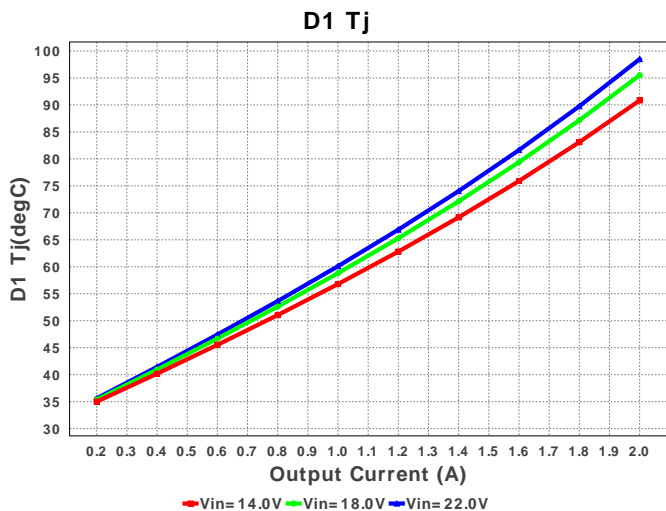

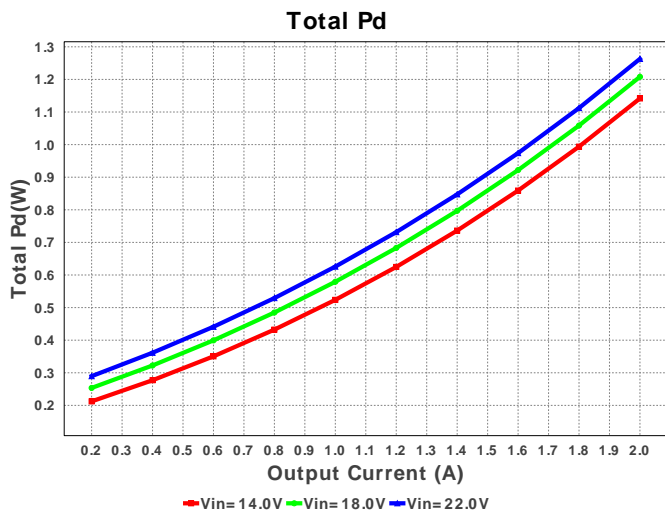
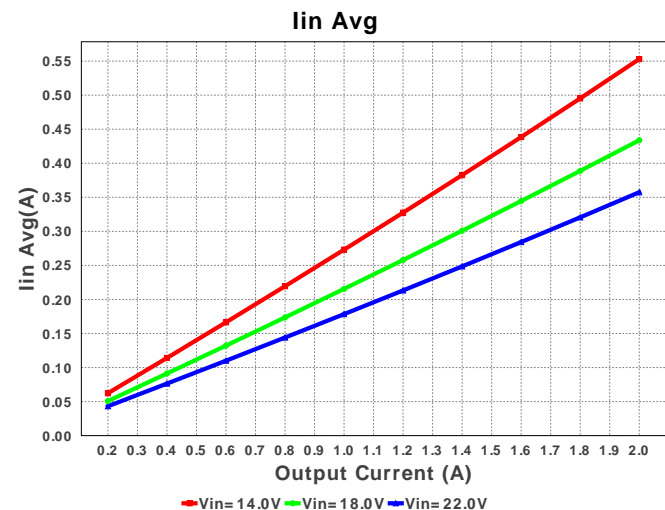
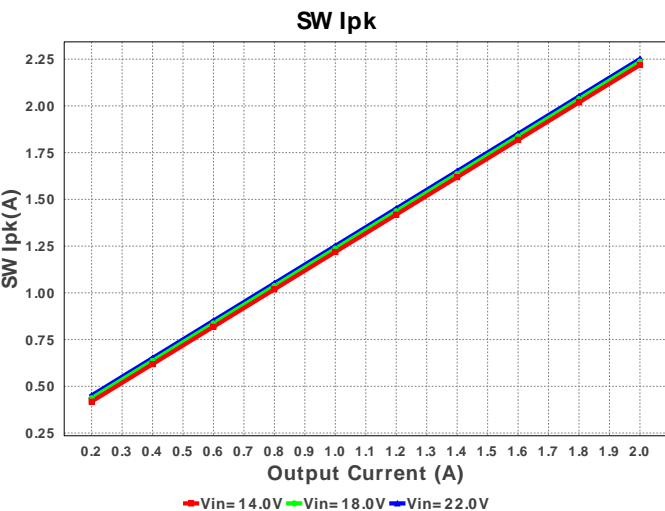
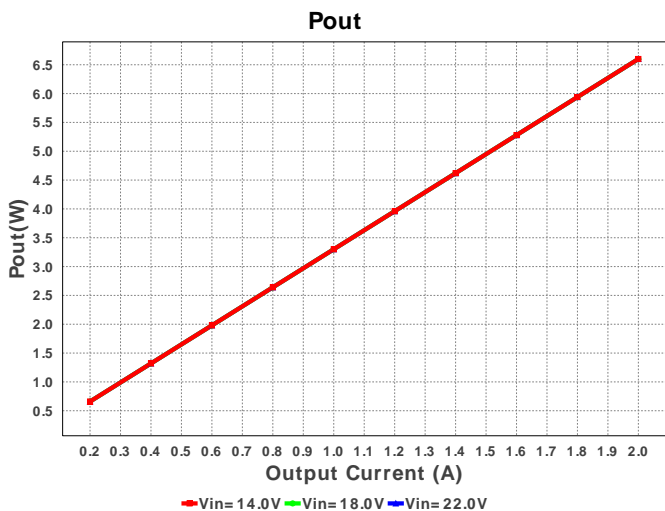
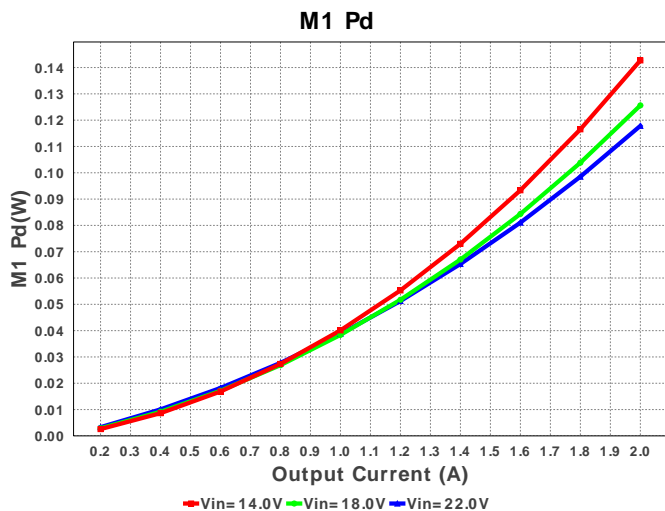
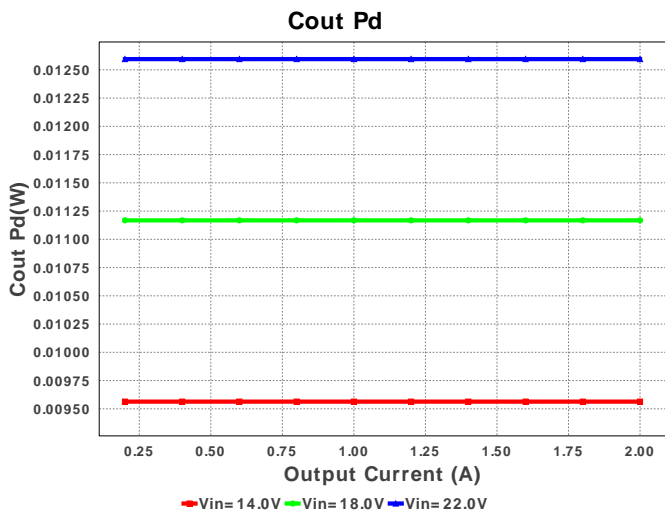



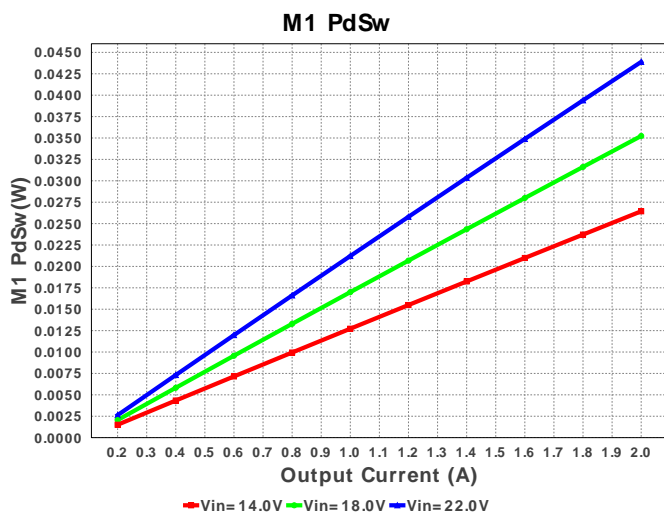
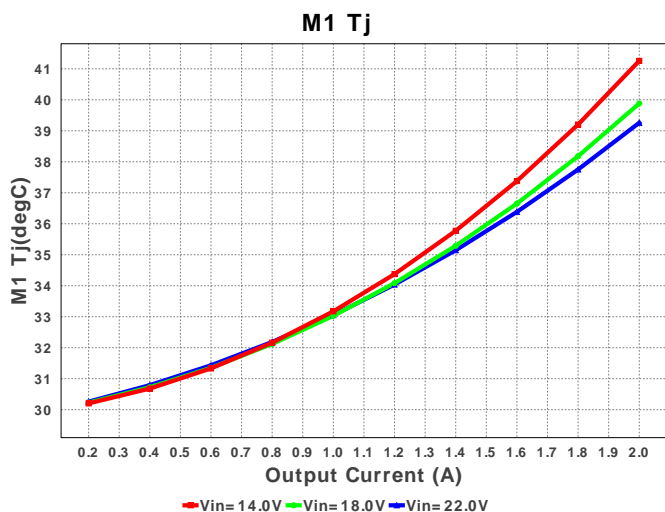
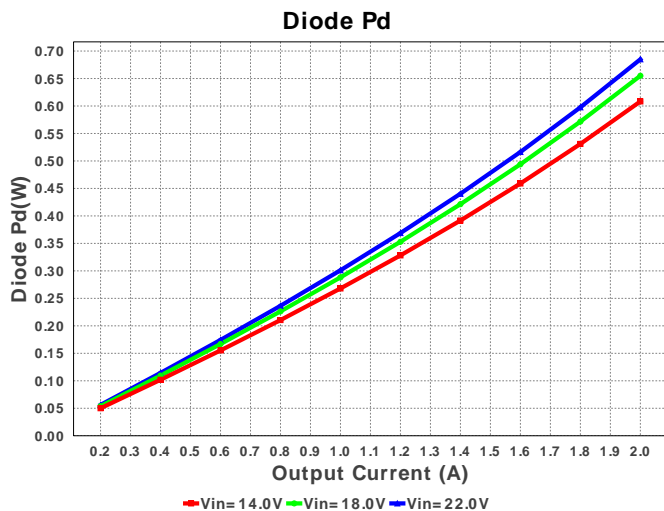
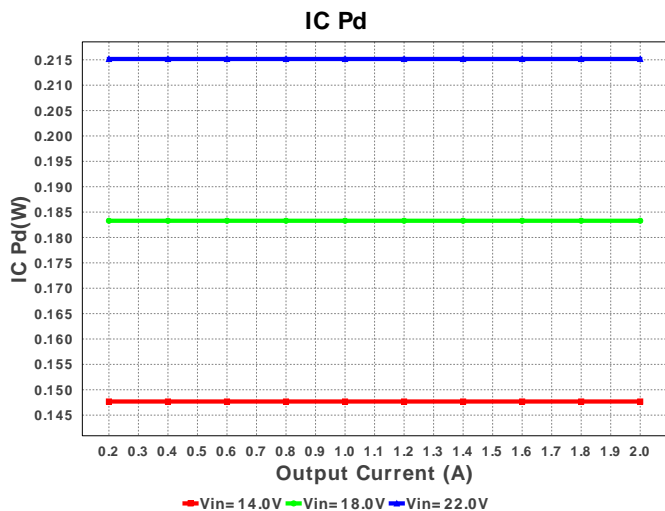
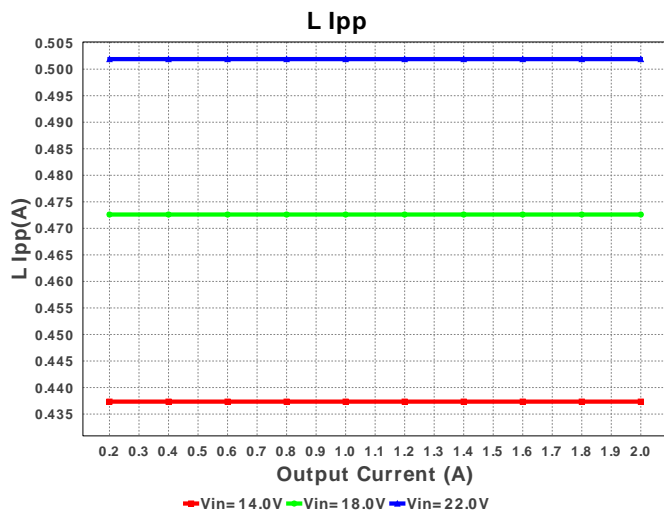
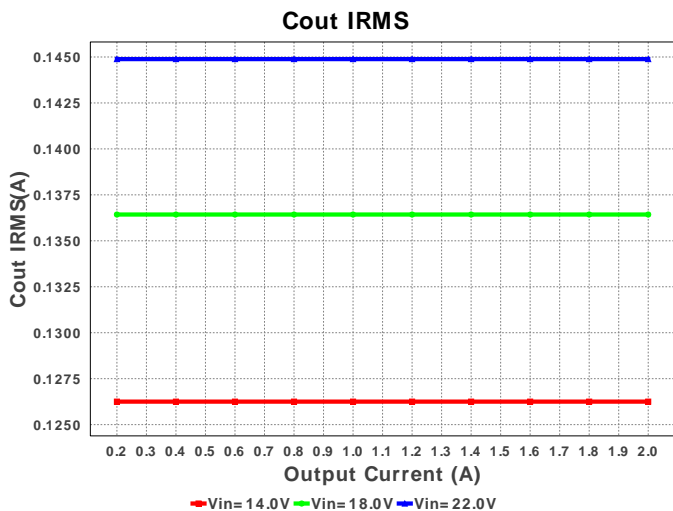

### Operating Values

#	Name	Value	Category	Description
1.	Cin IRMS	744.614 mA	Current	Input capacitor RMS ripple current
2.	Cout IRMS	144.885 mA	Current	Output capacitor RMS ripple current
3.	Iin Avg	357.41 mA	Current	Average input current
4.	L Ipp	501.9 mA	Current	Peak-to-peak inductor ripple current
5.	SW Ipk	2.251 A	Current	Peak switch current
6.	BOM Count	14	General	Total Design BOM count
7.	FootPrint	254.0 mm <sup>2</sup>	General	Total Foot Print Area of BOM components
8.	Frequency	471.114 kHz	General	Switching frequency
9.	IC Tolerance	25.0 mV	General	IC Feedback Tolerance
10.	Mode	CCM	General	Conduction Mode
11.	Pout	6.6 W	General	Total output power

#	Name	Value	Category	Description
12.	Total BOM	\$1.83	General	Total BOM Cost
13.	D1 Tj	98.497 degC	Op_Point	D1 junction temperature
14.	Vout Actual	3.292 V	Op_Point	Vout Actual calculated based on selected voltage divider resistors
15.	Vout OP	3.3 V	Op_Point	Operational Output Voltage
16.	Duty Cycle	16.625 %	Op_point	Duty cycle
17.	Efficiency	83.937 %	Op_point	Steady state efficiency
18.	IC Tj	39.897 degC	Op_point	IC junction temperature
19.	ICThetaJA	46.0 degC/W	Op_point	IC junction-to-ambient thermal resistance
20.	IOUT_OP	2.0 A	Op_point	Iout operating point
21.	M1 Tj	39.258 degC	Op_point	M1 MOSFET junction temperature
22.	VIN_OP	22.0 V	Op_point	Vin operating point
23.	Vout p-p	301.165 mV	Op_point	Peak-to-peak output ripple voltage
24.	Cin Pd	2.466 mW	Power	Input capacitor power dissipation
25.	Cout Pd	12.595 mW	Power	Output capacitor power dissipation
26.	Diode Pd	684.967 mW	Power	Diode power dissipation
27.	IC Pd	215.161 mW	Power	IC power dissipation
28.	L Pd	190.0 mW	Power	Inductor power dissipation
29.	M1 Pd	117.836 mW	Power	M1 MOSFET total power dissipation
30.	M1 PdCond	73.946 mW	Power	M1 MOSFET conduction losses
31.	M1 PdSw	43.89 mW	Power	M1 MOSFET switching losses
32.	Total Pd	1.263 W	Power	Total Power Dissipation
33.	Vout Tolerance	2.697 %		Vout Tolerance based on IC Tolerance (no load) and voltage divider resistors if applicable

## Design Inputs

#	Name	Value	Description
1.	Iout	2.0	Maximum Output Current
2.	VinMax	22.0	Maximum input voltage
3.	VinMin	14.0	Minimum input voltage
4.	Vout	3.3	Output Voltage
5.	base_pn	LM5085	Texas Instruments Base Part Number
6.	source	DC	Input Source Type
7.	ta	30.0	Ambient temperature

## Design Assistance

1. For a Constant On Time device to be stable, we need to provide a ripple at the feedback comparator. There are various methods to implement the ripple. Depending on the circuit complexity vs. the allowable ripple, we have three options to choose from. The simplest option, 'Low Complexity', would require only a high ESR cap at the output. This means that the BOM count will be small, but the output voltage ripple will be quite large. The 'optimal solution' would require a feed-forward cap in parallel with the upper feedback resistor to AC couple the ripple to the feedback node. This increases the BOM count slightly, but now we have more control over the output voltage ripple. If the output voltage requirement is very tight, then the best option is to go for the 'Low Output Ripple' solution. In this option we can go with very low ESR output caps and have very good control over the output voltage ripple

2. LM5085 Product Folder : <http://www.ti.com/product/LM5085> : contains the data sheet and other resources.

Texas Instruments' WEBENCH simulation tools attempt to recreate the performance of a substantially equivalent physical implementation of the design. Simulations are created using Texas Instruments' published specifications as well as the published specifications of other device manufacturers. While Texas Instruments does update this information periodically, this information may not be current at the time the simulation is built. Texas Instruments does not warrant the accuracy or completeness of the specifications or any information contained therein. Texas Instruments does not warrant that any designs or recommended parts will meet the specifications you entered, will be suitable for your application or fit for any particular purpose, or will operate as shown in the simulation in a physical implementation. Texas Instruments does not warrant that the designs are production worthy.

**You should completely validate and test your design implementation to confirm the system functionality for your application prior to production.**

Use of Texas Instruments' WEBENCH simulation tools is subject to [Texas Instruments' Site Terms and Conditions of Use](#). Prototype boards based on WEBENCH created designs are provided AS IS without warranty of any kind for evaluation and testing purposes and are subject to the terms of the [Evaluation License Agreement](#).