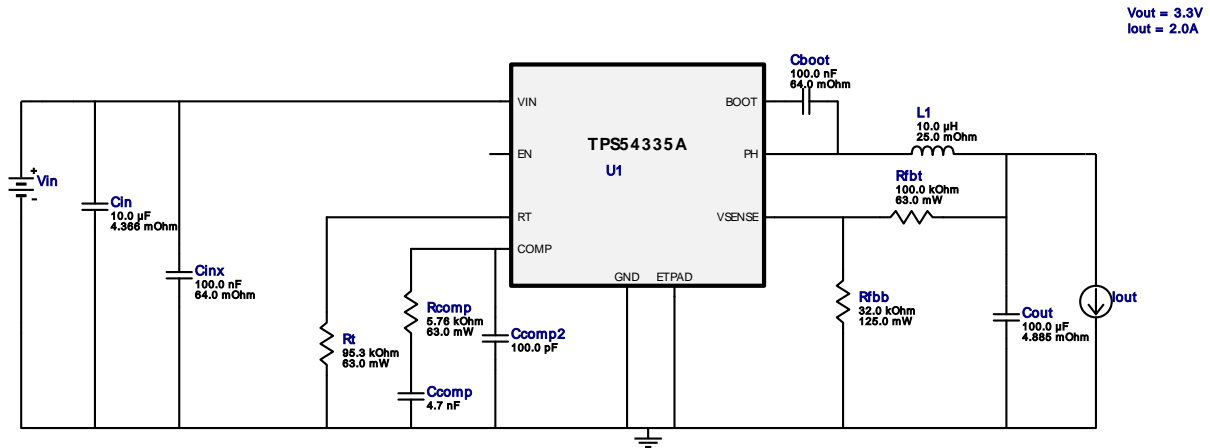

WEBENCH® Design Report

 Design : 4778710/4 TPS54335ADDAR
 TPS54335ADDAR 14.0V-22.0V to 3.30V @ 2.0A

 Vout = 3.3V
 Iout = 2.0A

Electrical BOM

| # | Name | Manufacturer | Part Number | Properties | Qty | Price | Footprint |
|-----|--------|---------------|--------------------------------------|--|-----|--------|--|
| 1. | Cboot | Kemet | C0805C104K5RACTU Series= X7R | Cap= 100.0 nF ESR= 64.0 mOhm VDC= 50.0 V IRMS= 1.64 A | 1 | \$0.01 | 0805 7 mm ² |
| 2. | Ccomp | Yageo America | CC0805KRX7R9BB472 Series= X7R | Cap= 4.7 nF VDC= 50.0 V IRMS= 0.0 A | 1 | \$0.01 | 0805 7 mm ² |
| 3. | Ccomp2 | Yageo America | CC0805JRNPO9BN101 Series= C0G/NP0 | Cap= 100.0 pF VDC= 50.0 V IRMS= 0.0 A | 1 | \$0.01 | 0805 7 mm ² |
| 4. | Cin | MuRata | GRM31CR71E106KA12L Series= X7R | Cap= 10.0 uF ESR= 4.366 mOhm VDC= 25.0 V IRMS= 2.8022 A | 1 | \$0.05 | 1206_190 11 mm ² |
| 5. | Cinx | Kemet | C0805C104K5RACTU Series= X7R | Cap= 100.0 nF ESR= 64.0 mOhm VDC= 50.0 V IRMS= 1.64 A | 1 | \$0.01 | 0805 7 mm ² |
| 6. | Cout | MuRata | GRM31CR60J107ME39L Series= X5R | Cap= 100.0 uF ESR= 4.885 mOhm VDC= 6.3 V IRMS= 4.4118 A | 1 | \$0.14 | 1206_190 11 mm ² |
| 7. | L1 | Bourns | SRU1038-100Y | L= 10.0 uH DCR= 25.0 mOhm | 1 | \$0.33 |  SRU1038 144 mm ² |
| 8. | Rcomp | Vishay-Dale | CRCW04025K76FKED Series= CRCW..e3 | Res= 5.76 kOhm Power= 63.0 mW Tolerance= 1.0% | 1 | \$0.01 | 0402 3 mm ² |
| 9. | Rfbb | Yageo America | RT0805BRD0732KL Series= ? | Res= 32.0 kOhm Power= 125.0 mW Tolerance= 0.1% | 1 | \$0.05 | 0805 7 mm ² |
| 10. | Rfht | Vishay-Dale | CRCW0402100KFKED Series= CRCW..e3 | Res= 100.0 kOhm Power= 63.0 mW Tolerance= 1.0% | 1 | \$0.01 | 0402 3 mm ² |

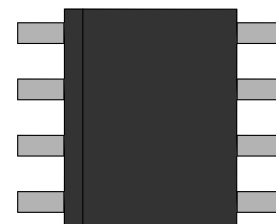
| # | Name | Manufacturer | Part Number | Properties | Qty | Price | Footprint |
|-----|------|-------------------|--------------------------------------|---|-----|--------|------------------------|
| 11. | Rt | Vishay-Dale | CRCW040295K3FKED Series= CRCW..e3 | Res= 95.3 kOhm Power= 63.0 mW Tolerance= 1.0% | 1 | \$0.01 | 0402 3 mm ² |
| 12. | U1 | Texas Instruments | TPS54335ADDAR | Switcher | 1 | \$0.90 | |



R-PDSO-G8 55 mm²

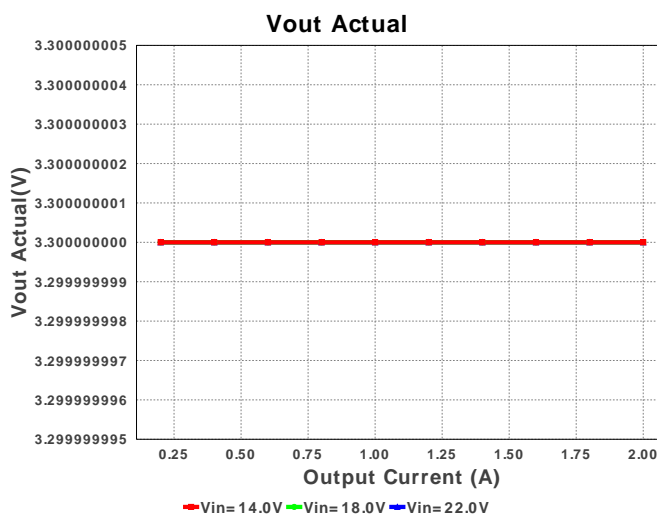
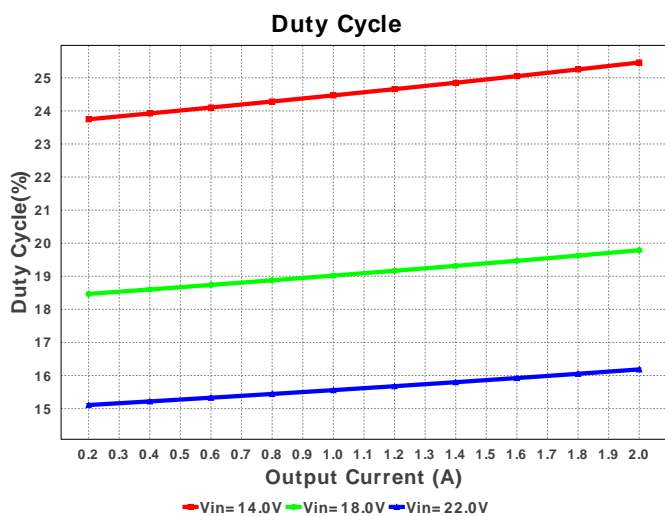
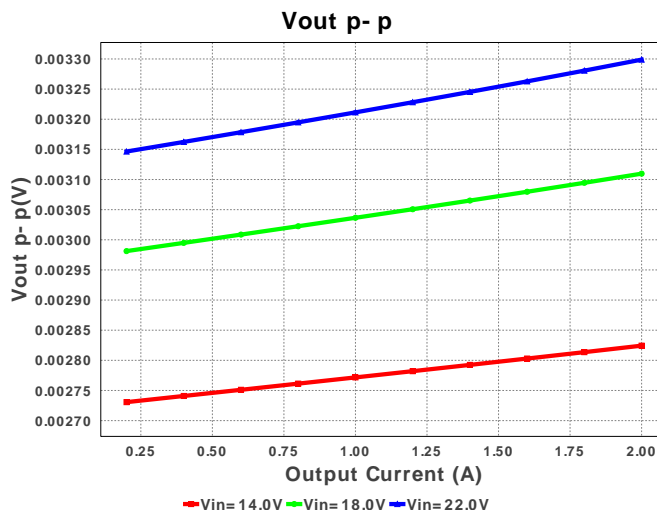
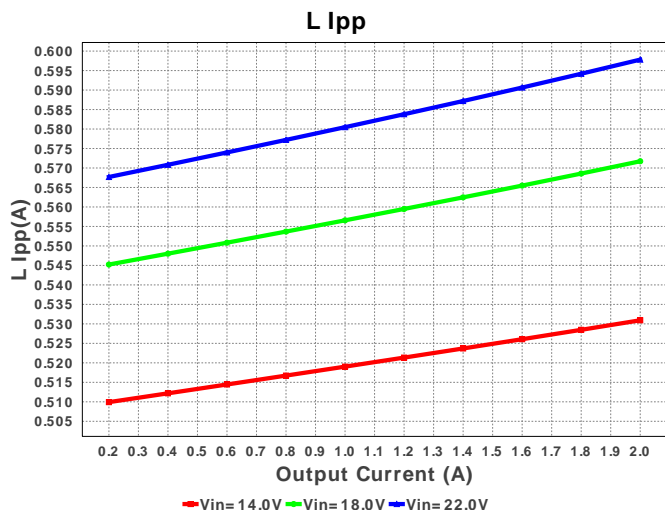

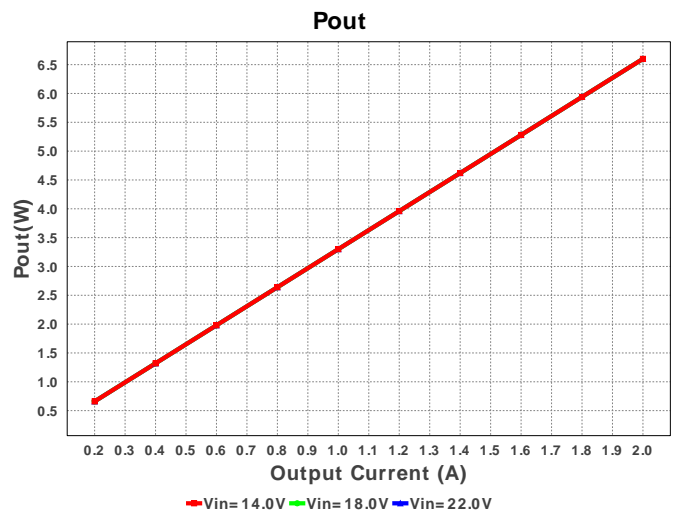
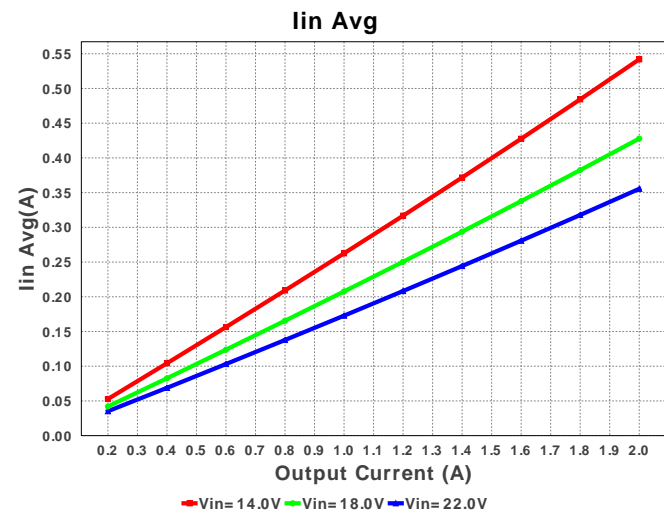
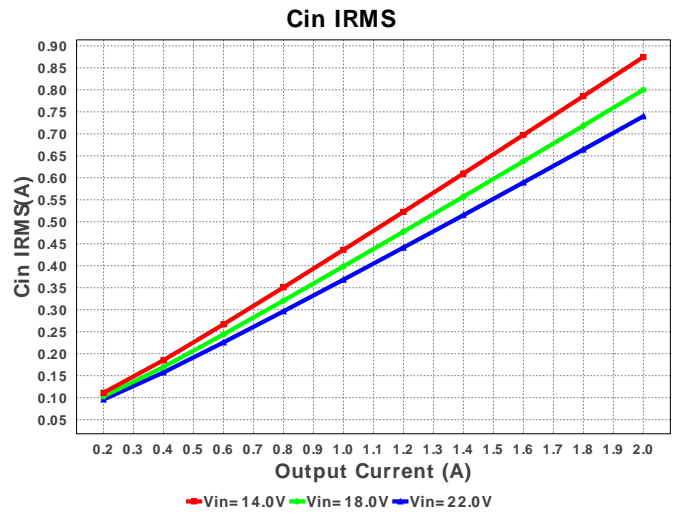
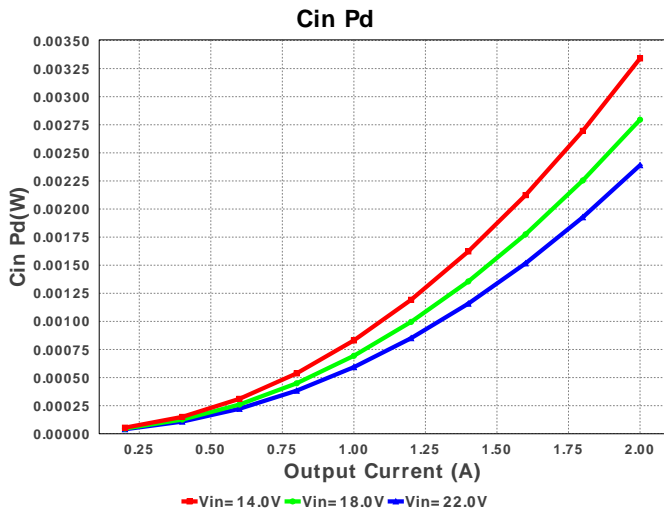
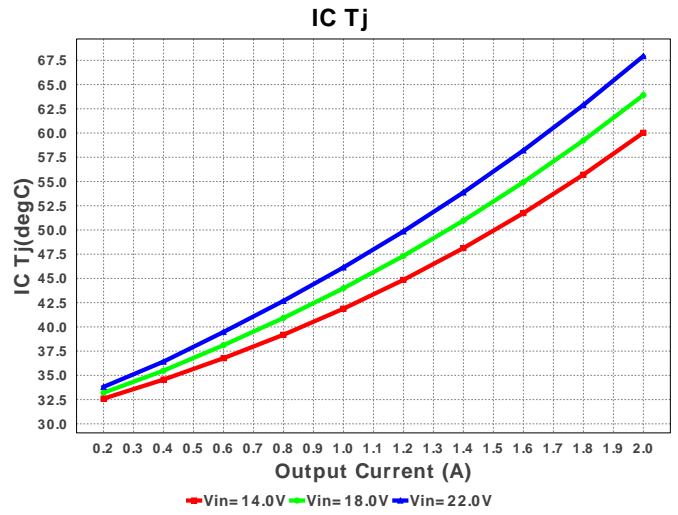
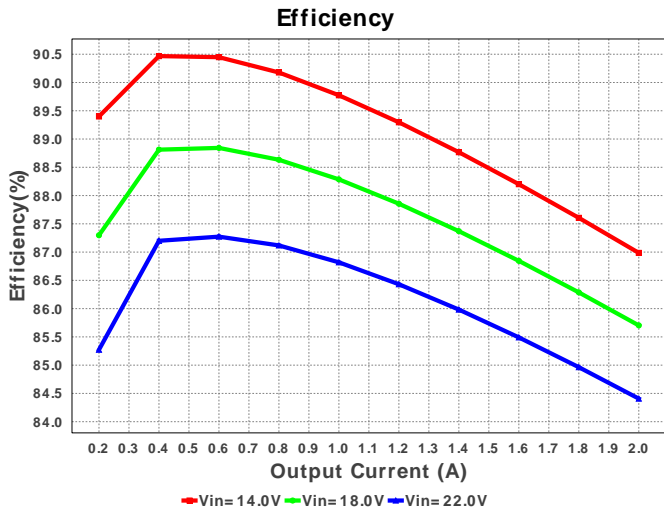

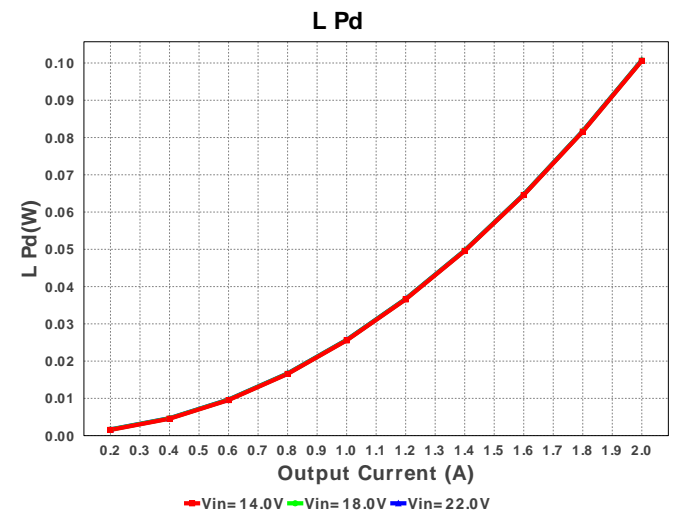
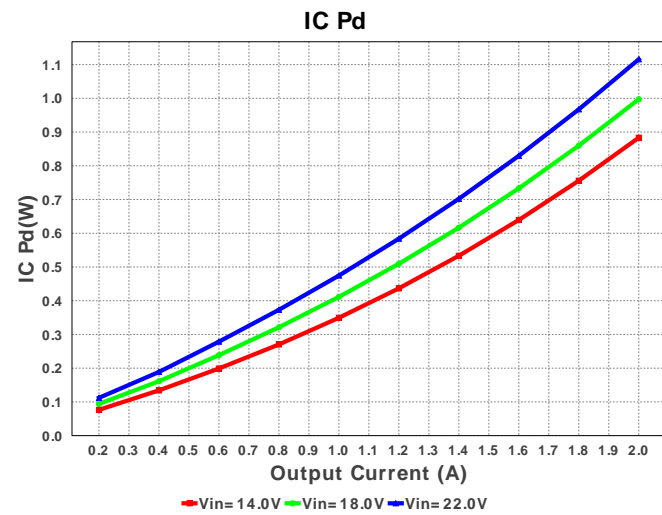
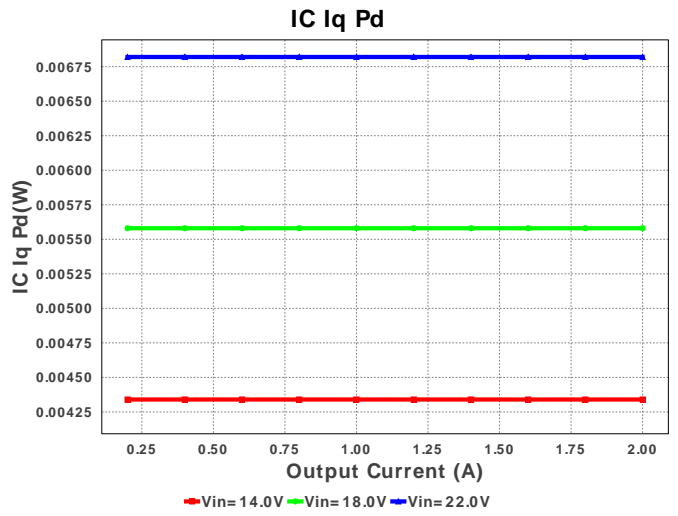
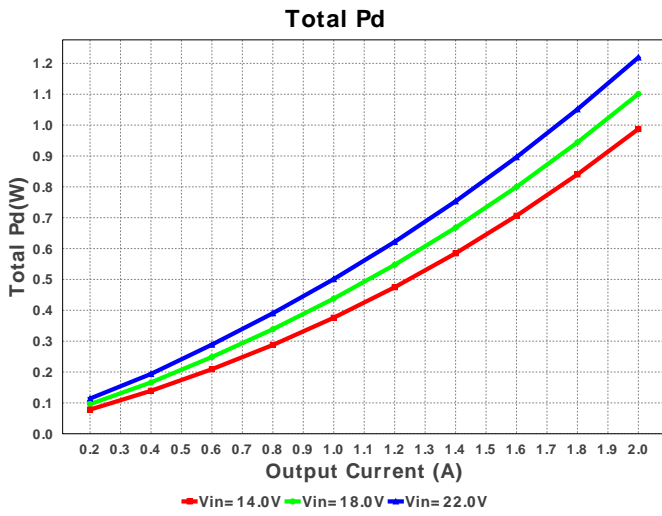
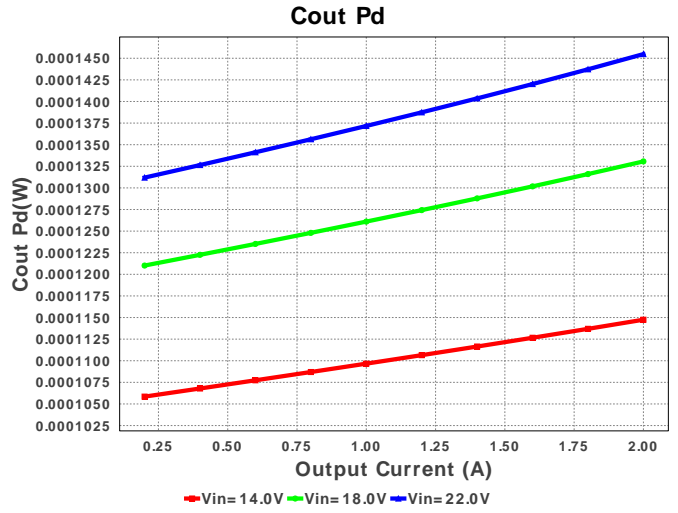
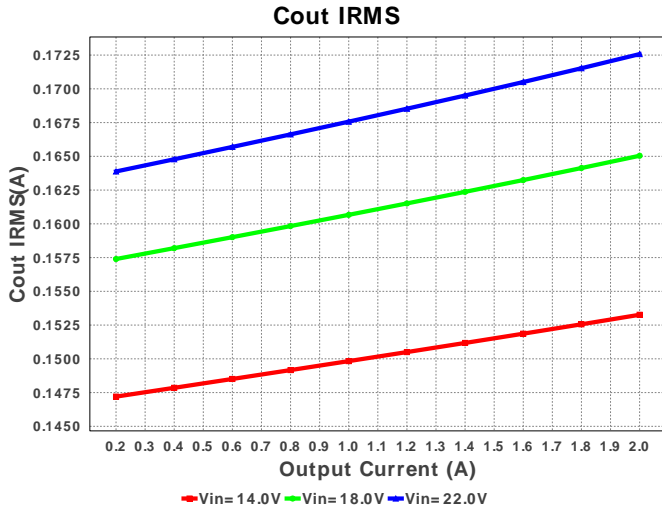

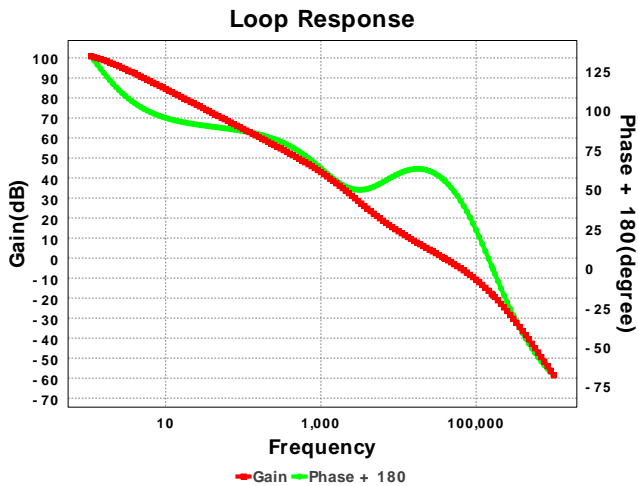

Operating Values

| # | Name | Value | Category | Description |
|-----|---------------------|-----------------------|----------|--|
| 1. | Cin IRMS | 739.877 mA | Current | Input capacitor RMS ripple current |
| 2. | Cout IRMS | 172.573 mA | Current | Output capacitor RMS ripple current |
| 3. | Iin Avg | 355.42 mA | Current | Average input current |
| 4. | L Ipp | 597.81 mA | Current | Peak-to-peak inductor ripple current |
| 5. | BOM Count | 12 | General | Total Design BOM count |
| 6. | FootPrint | 264.0 mm ² | General | Total Foot Print Area of BOM components |
| 7. | Frequency | 496.814 kHz | General | Switching frequency |
| 8. | IC Tolerance | 12.0 mV | General | IC Feedback Tolerance |
| 9. | Mode | CCM | General | Conduction Mode |
| 10. | Pout | 6.6 W | General | Total output power |
| 11. | Total BOM | \$1.54 | General | Total BOM Cost |
| 12. | ICThetaJA Effective | 34.0 degC/W | Op_Point | Effective IC Junction-to-Ambient Thermal Resistance |
| 13. | Low Freq Gain | 100.743 dB | Op_Point | Gain at 10Hz |
| 14. | Vout Actual | 3.3 V | Op_Point | Vout Actual calculated based on selected voltage divider resistors |
| 15. | Vout OP | 3.3 V | Op_Point | Operational Output Voltage |
| 16. | Cross Freq | 38.81 kHz | Op_point | Bode plot crossover frequency |
| 17. | Duty Cycle | 16.184 % | Op_point | Duty cycle |
| 18. | Efficiency | 84.408 % | Op_point | Steady state efficiency |
| 19. | Gain Marg | -18.499 dB | Op_point | Bode Plot Gain Margin |
| 20. | IC Tj | 67.937 degC | Op_point | IC junction temperature |
| 21. | IOUT_OP | 2.0 A | Op_point | Iout operating point |
| 22. | Phase Marg | 56.318 deg | Op_point | Bode Plot Phase Margin |
| 23. | VIN_OP | 22.0 V | Op_point | Vin operating point |
| 24. | Vout p-p | 3.299 mV | Op_point | Peak-to-peak output ripple voltage |
| 25. | Cin Pd | 2.39 mW | Power | Input capacitor power dissipation |
| 26. | Cout Pd | 145.482 μW | Power | Output capacitor power dissipation |
| 27. | IC Iq Pd | 6.82 mW | Power | IC Iq Pd |
| 28. | IC Pd | 1.116 W | Power | IC power dissipation |
| 29. | L Pd | 100.745 mW | Power | Inductor power dissipation |
| 30. | Total Pd | 1.219 W | Power | Total Power Dissipation |
| 31. | Vout Tolerance | 2.347 % | | Vout Tolerance based on IC Tolerance (no load) and voltage divider resistors if applicable |

Design Inputs

| # | Name | Value | Description |
|----|---------|-----------|------------------------|
| 1. | Iout | 2.0 | Maximum Output Current |
| 2. | VinMax | 22.0 | Maximum input voltage |
| 3. | VinMin | 14.0 | Minimum input voltage |
| 4. | Vout | 3.3 | Output Voltage |
| 5. | base_pn | TPS54335A | Base Product Number |
| 6. | source | DC | Input Source Type |
| 7. | Ta | 30.0 | Ambient temperature |

Design Assistance

1. **TPS54335A** Product Folder : <http://www.ti.com/product/TPS54335A> : contains the data sheet and other resources.

Texas Instruments' WEBENCH simulation tools attempt to recreate the performance of a substantially equivalent physical implementation of the design. Simulations are created using Texas Instruments' published specifications as well as the published specifications of other device manufacturers. While Texas Instruments does update this information periodically, this information may not be current at the time the simulation is built. Texas Instruments does not warrant the accuracy or completeness of the specifications or any information contained therein. Texas Instruments does not warrant that any designs or recommended parts will meet the specifications you entered, will be suitable for your application or fit for any particular purpose, or will operate as shown in the simulation in a physical implementation. Texas Instruments does not warrant that the designs are production worthy.

You should completely validate and test your design implementation to confirm the system functionality for your application prior to production.

Use of Texas Instruments' WEBENCH simulation tools is subject to [Texas Instruments' Site Terms and Conditions of Use](#). Prototype boards based on WEBENCH created designs are provided AS IS without warranty of any kind for evaluation and testing purposes and are subject to the terms of the [Evaluation License Agreement](#).