

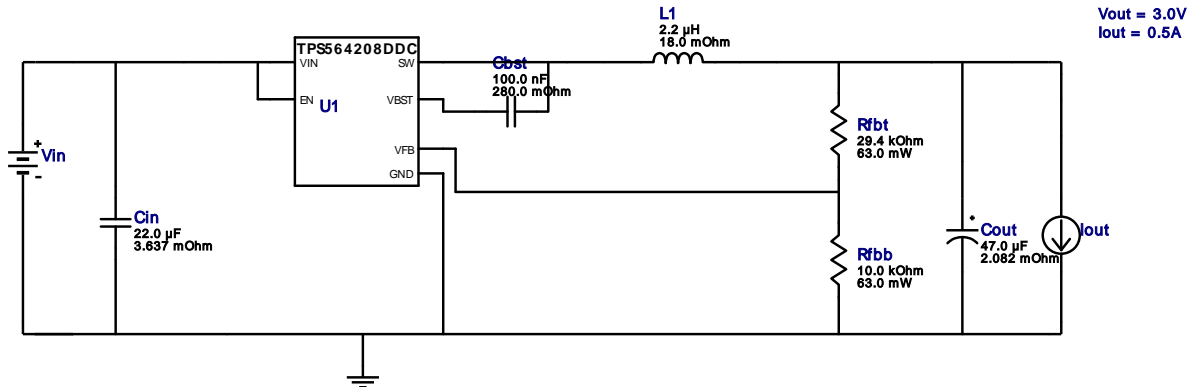







WEBENCH® Design Report

 Design : 4742013/135 TPS564208DDCR
 TPS564208DDCR 4.5V-5.5V to 3.00V @ 0.5A

Electrical BOM

#	Name	Manufacturer	Part Number	Properties	Qty	Price	Footprint
1.	Cbst	AVX	08053C104KAT2A Series= X7R	Cap= 100.0 nF ESR= 280.0 mOhm VDC= 25.0 V IRMS= 0.0 A	1	\$0.01	 0805 7 mm ²
2.	Cin	MuRata	GRM31CR61A226KE19L Series= X5R	Cap= 22.0 uF ESR= 3.637 mOhm VDC= 10.0 V IRMS= 3.56456 A	1	\$0.07	 1206_190 11 mm ²
3.	Cout	TDK	C3216X5R1E476M160AC Series= X5R	Cap= 47.0 uF ESR= 2.082 mOhm VDC= 25.0 V IRMS= 5.0279 A	1	\$0.35	 1206 11 mm ²
4.	L1	Coilcraft	MSS5131-222MLB	L= 2.2 uH DCR= 18.0 mOhm	1	\$0.48	 MSS5131 50 mm ²
5.	Rfbb	Vishay-Dale	CRCW040210K0FKED Series= CRCW..e3	Res= 10.0 kOhm Power= 63.0 mW Tolerance= 1.0%	1	\$0.01	 0402 3 mm ²
6.	Rfbt	Vishay-Dale	CRCW040229K4FKED Series= CRCW..e3	Res= 29.4 kOhm Power= 63.0 mW Tolerance= 1.0%	1	\$0.01	 0402 3 mm ²
7.	U1	Texas Instruments	TPS564208DDCR	Switcher	1	\$0.50	 DDC0006A_N 10 mm ²

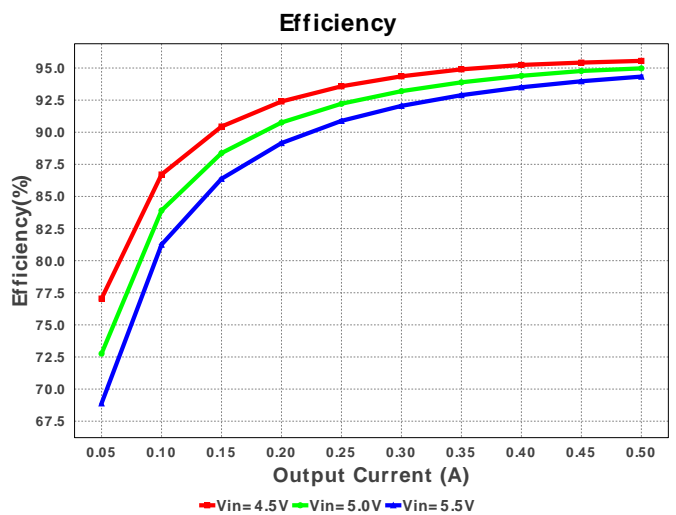
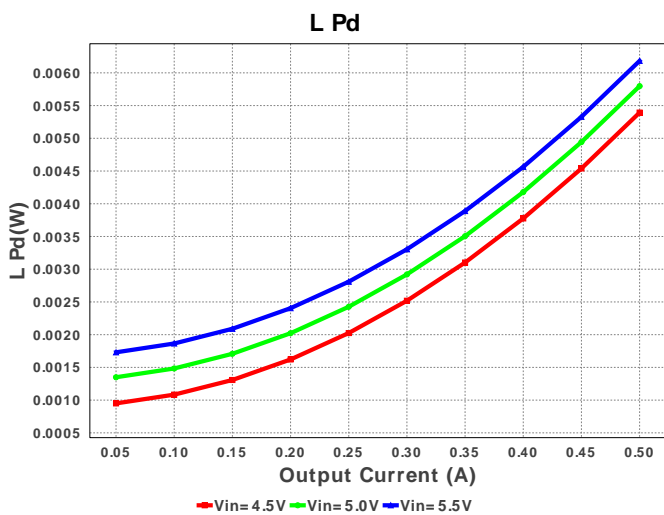
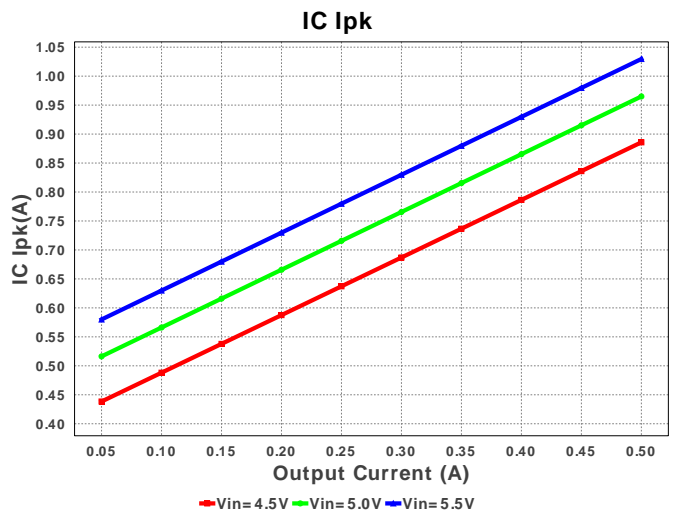
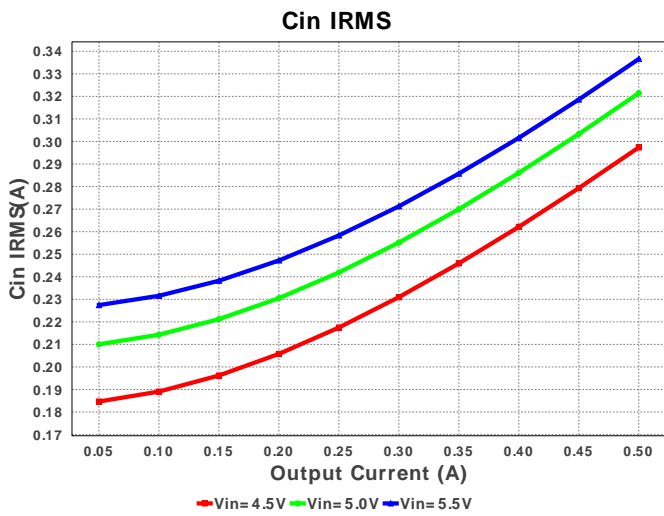
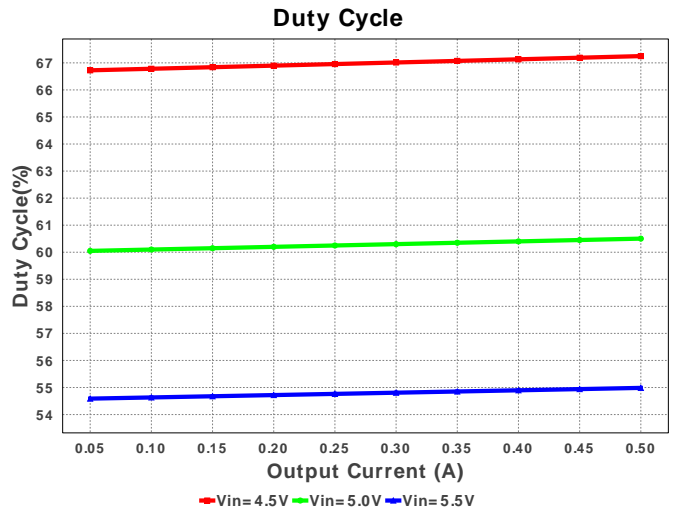
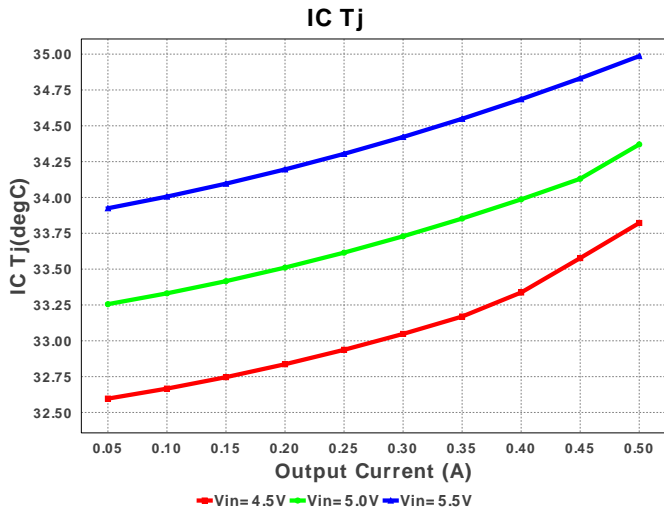
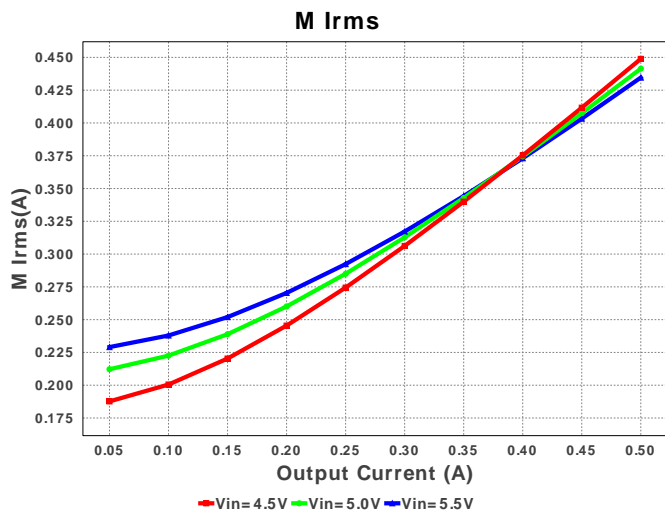
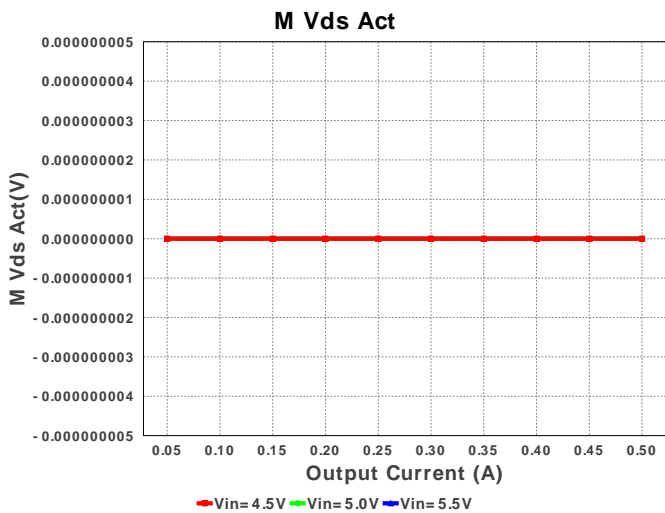
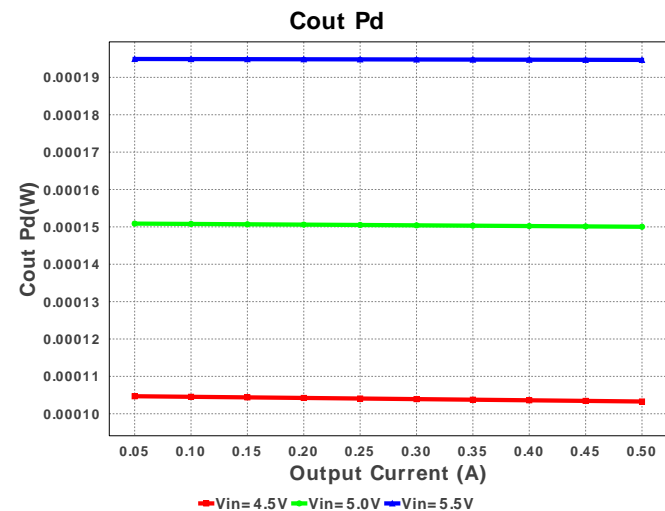
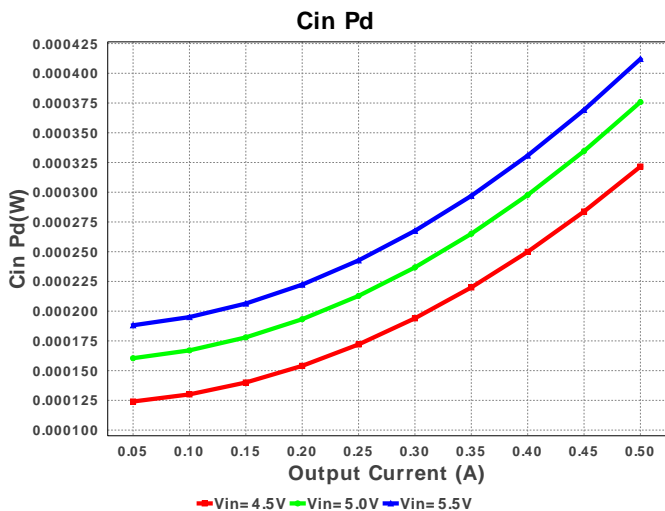
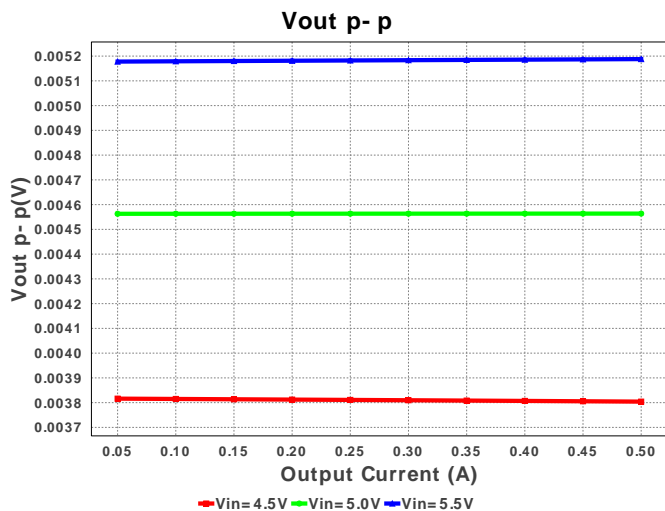
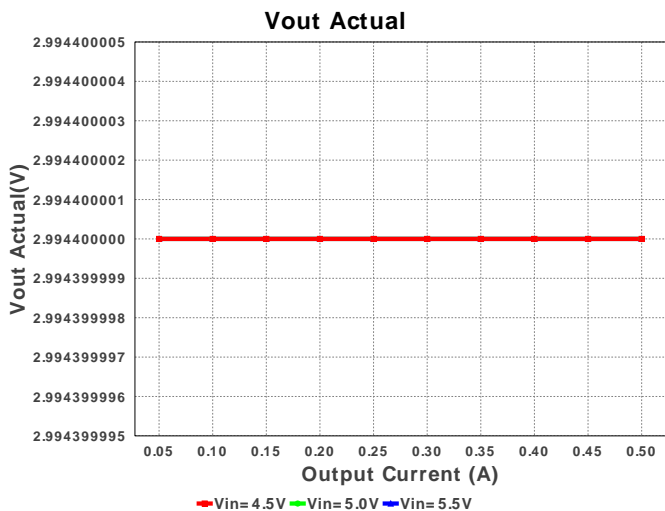

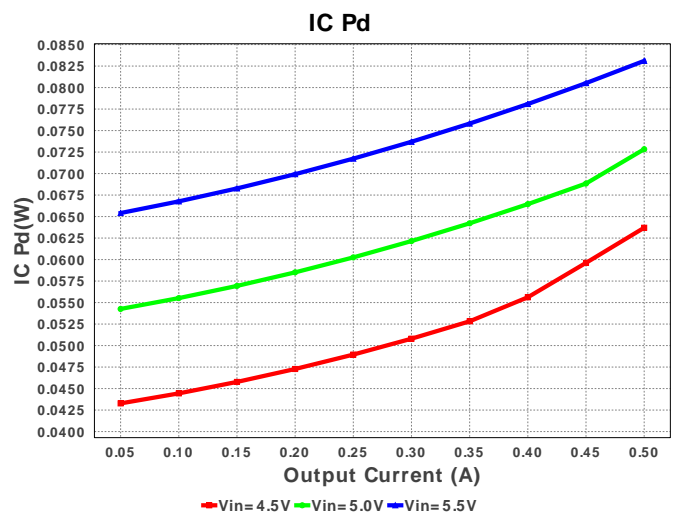
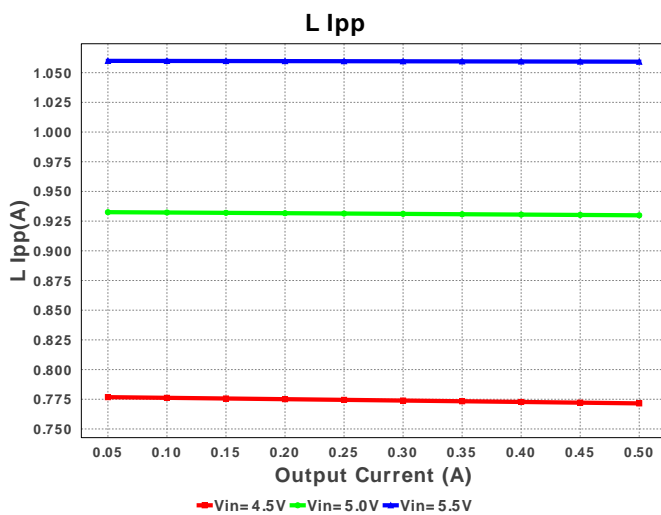
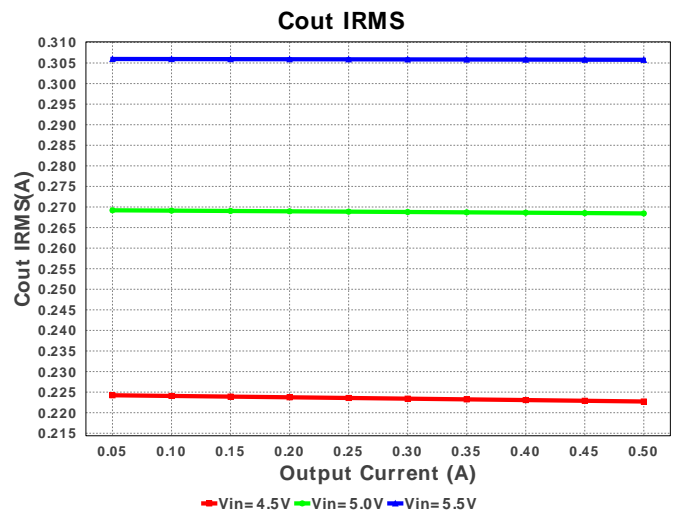
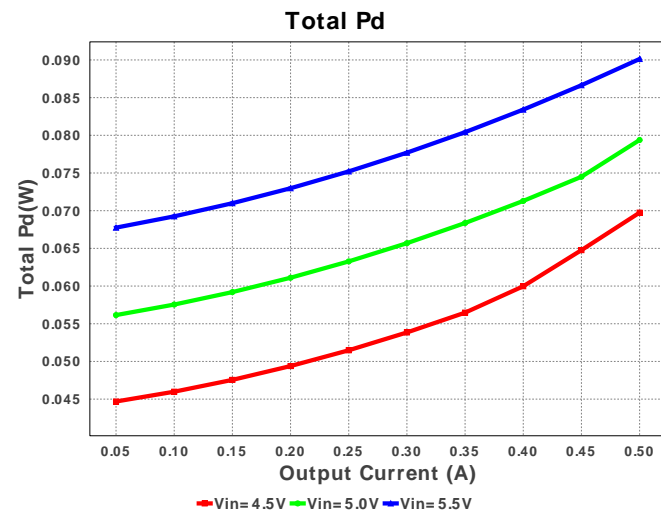
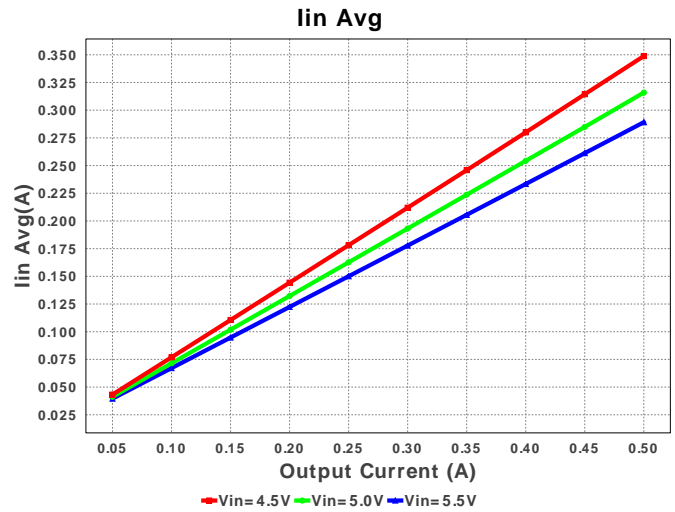
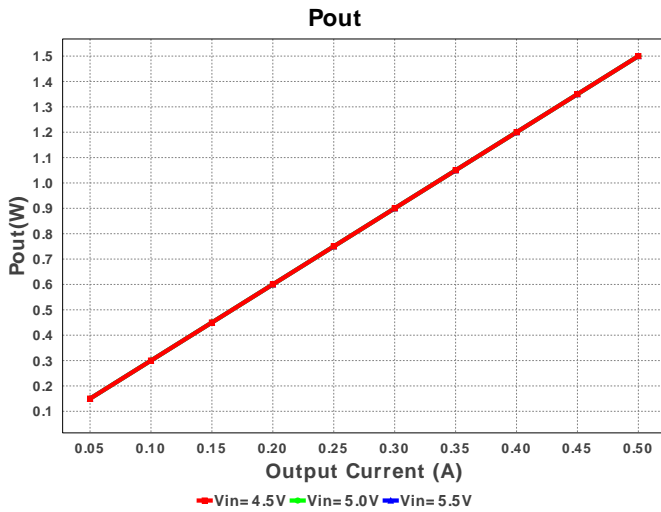



Operating Values

#	Name	Value	Category	Description
1.	Cin IRMS	336.586 mA	Current	Input capacitor RMS ripple current
2.	Cout IRMS	305.778 mA	Current	Output capacitor RMS ripple current
3.	IC Ipk	1.03 A	Current	Peak switch current in IC
4.	Iin Avg	289.11 mA	Current	Average input current
5.	L Ipp	1.059 A	Current	Peak-to-peak inductor ripple current
6.	M1 Irms	434.599 mA	Current	Q lavg
7.	BOM Count	7	General	Total Design BOM count
8.	FootPrint	95.0 mm ²	General	Total Foot Print Area of BOM components
9.	Frequency	582.953 kHz	General	Switching frequency
10.	IC Tolerance	10.0 mV	General	IC Feedback Tolerance
11.	M Vds Act	0.0 V	General	Voltage drop across the MosFET

#	Name	Value	Category	Description
12.	Pout	1.5 W	General	Total output power
13.	Total BOM	\$1.43	General	Total BOM Cost
14.	Vout Actual	2.994 V	Op_Point	Vout Actual calculated based on selected voltage divider resistors
15.	Vout OP	3.0 V	Op_Point	Operational Output Voltage
16.	Duty Cycle	54.986 %	Op_point	Duty cycle
17.	Efficiency	94.332 %	Op_point	Steady state efficiency
18.	IC Tj	34.986 degC	Op_point	IC junction temperature
19.	ICThetaJA	60.0 degC/W	Op_point	IC junction-to-ambient thermal resistance
20.	IOUT_OP	500.0 mA	Op_point	Iout operating point
21.	VIN_OP	5.5 V	Op_point	Vin operating point
22.	Vout p-p	5.188 mV	Op_point	Peak-to-peak output ripple voltage
23.	Cin Pd	412.037 μW	Power	Input capacitor power dissipation
24.	Cout Pd	194.668 μW	Power	Output capacitor power dissipation
25.	IC Pd	83.105 mW	Power	IC power dissipation
26.	L Pd	6.183 mW	Power	Inductor power dissipation
27.	Total Pd	90.127 mW	Power	Total Power Dissipation
28.	Vout Tolerance	2.843 %		Vout Tolerance based on IC Tolerance (no load) and voltage divider resistors if applicable

Design Inputs

#	Name	Value	Description
1.	Iout	500.0 m	Maximum Output Current
2.	VinMax	5.5	Maximum input voltage
3.	VinMin	4.5	Minimum input voltage
4.	Vout	3.0	Output Voltage
5.	base_pn	TPS564208	Base Product Number
6.	source	DC	Input Source Type
7.	Ta	30.0	Ambient temperature

Design Assistance

1. **TPS564208** Product Folder : <http://www.ti.com/product/TPS564208> : contains the data sheet and other resources.

Texas Instruments' WEBENCH simulation tools attempt to recreate the performance of a substantially equivalent physical implementation of the design. Simulations are created using Texas Instruments' published specifications as well as the published specifications of other device manufacturers. While Texas Instruments does update this information periodically, this information may not be current at the time the simulation is built. Texas Instruments does not warrant the accuracy or completeness of the specifications or any information contained therein. Texas Instruments does not warrant that any designs or recommended parts will meet the specifications you entered, will be suitable for your application or fit for any particular purpose, or will operate as shown in the simulation in a physical implementation. Texas Instruments does not warrant that the designs are production worthy.

You should completely validate and test your design implementation to confirm the system functionality for your application prior to production.

Use of Texas Instruments' WEBENCH simulation tools is subject to [Texas Instruments' Site Terms and Conditions of Use](#). Prototype boards based on WEBENCH created designs are provided AS IS without warranty of any kind for evaluation and testing purposes and are subject to the terms of the [Evaluation License Agreement](#).