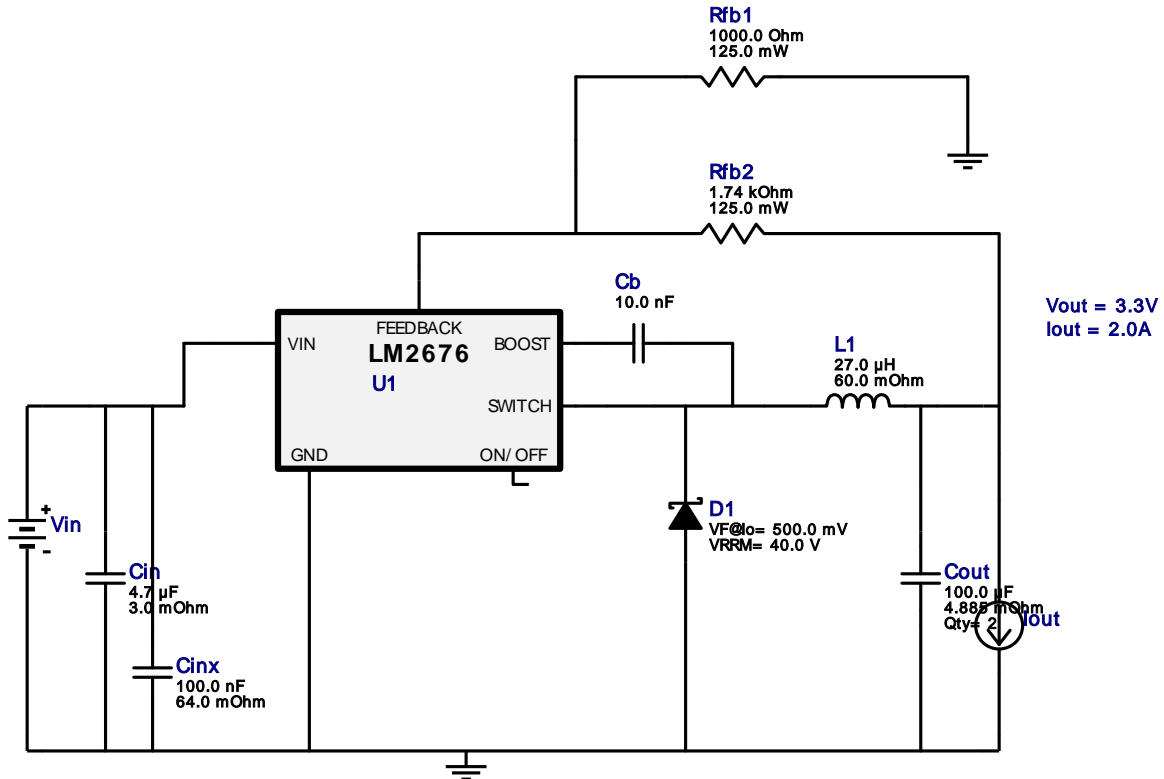
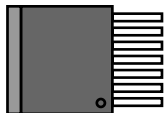
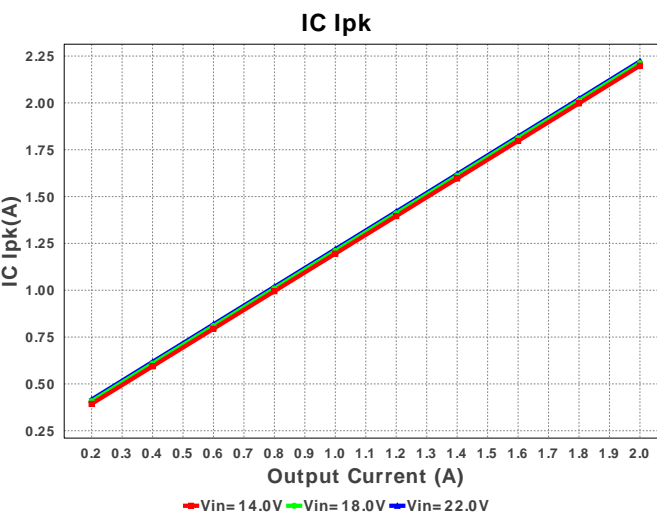
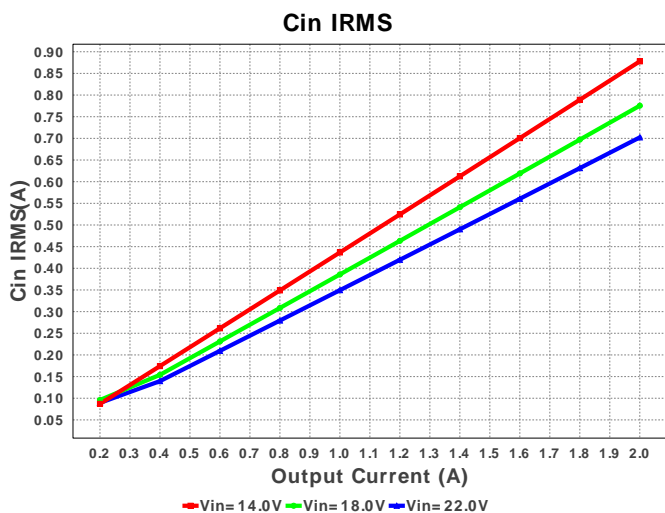
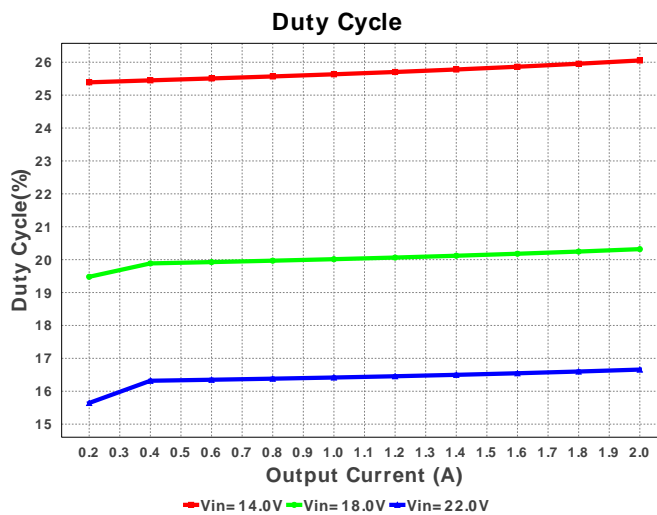
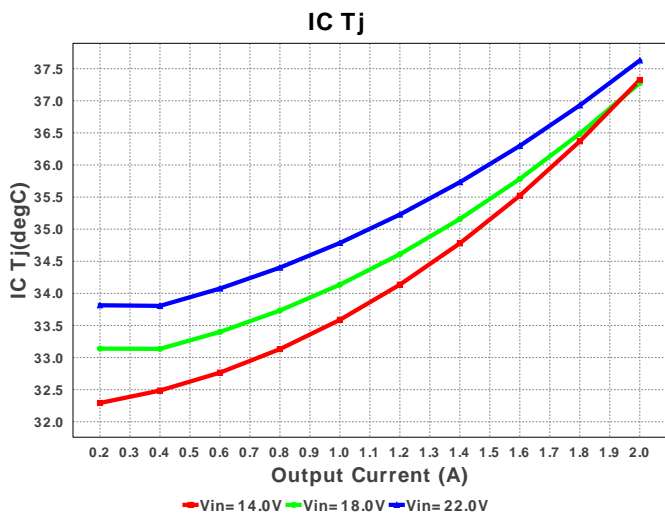

WEBENCH® Design Report

 Design : 4737567/52 LM2676SX-ADJ/NOPB
 LM2676SX-ADJ/NOPB 14.0V-22.0V to 3.30V @ 2.0A

Electrical BOM

#	Name	Manufacturer	Part Number	Properties	Qty	Price	Footprint
1.	Cb	MuRata	GRM216R71H103KA01D Series= X7R	Cap= 10.0 nF VDC= 50.0 V IRMS= 0.0 A	1	\$0.01	0805 7 mm ²
2.	Cin	MuRata	GRM31CR71H475KA12L Series= X7R	Cap= 4.7 uF ESR= 3.0 mOhm VDC= 50.0 V IRMS= 4.98 A	1	\$0.07	1206 11 mm ²
3.	Cinx	Kemet	C0805C104K5RACTU Series= X7R	Cap= 100.0 nF ESR= 64.0 mOhm VDC= 50.0 V IRMS= 1.64 A	1	\$0.01	0805 7 mm ²
4.	Cout	MuRata	GRM31CR60J107ME39L Series= X5R	Cap= 100.0 uF ESR= 4.885 mOhm VDC= 6.3 V IRMS= 4.4118 A	2	\$0.14	1206_190 11 mm ²
5.	D1	Diodes Inc.	B340A-13-F	VF@Io= 500.0 mV VRRM= 40.0 V	1	\$0.11	SMA 37 mm ²
6.	L1	Bourns	SDR1307-270ML	L= 27.0 uH DCR= 60.0 mOhm	1	\$0.35	SDR1307 227 mm ²

#	Name	Manufacturer	Part Number	Properties	Qty	Price	Footprint
7.	Rfb1	Panasonic	ERJ-6ENF1001V Series= ERJ-6E	Res= 1000.0 Ohm Power= 125.0 mW Tolerance= 1.0%	1	\$0.01	■ 0805 7 mm ²
8.	Rfb2	Panasonic	ERJ-6ENF1741V Series= ERJ-6E	Res= 1.74 kOhm Power= 125.0 mW Tolerance= 1.0%	1	\$0.01	■ 0805 7 mm ²
9.	U1	Texas Instruments	LM2676SX-ADJ/NOPB	Switcher	1	\$1.80	 TS7B 199 mm ²

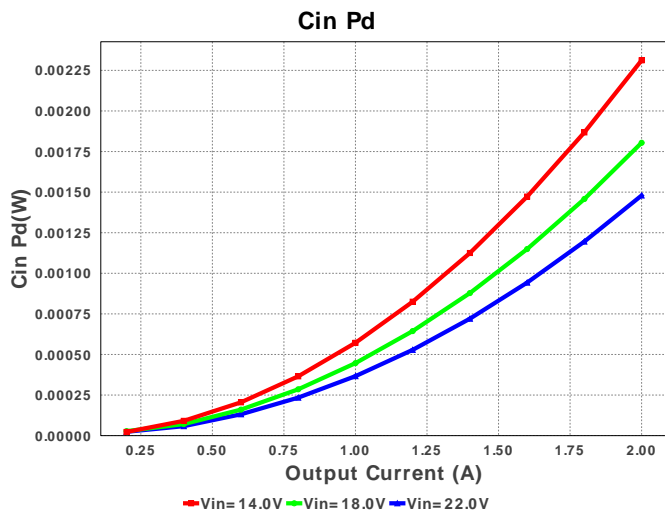
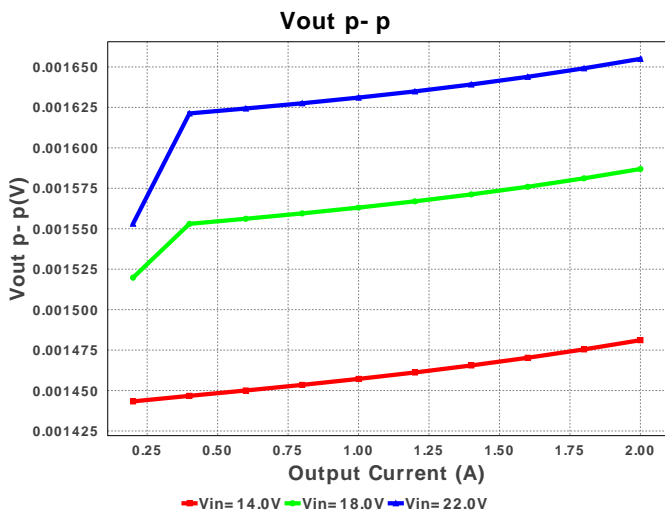
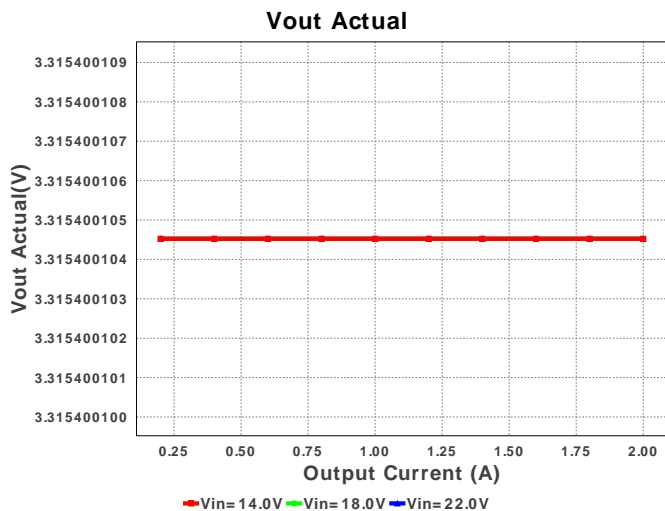
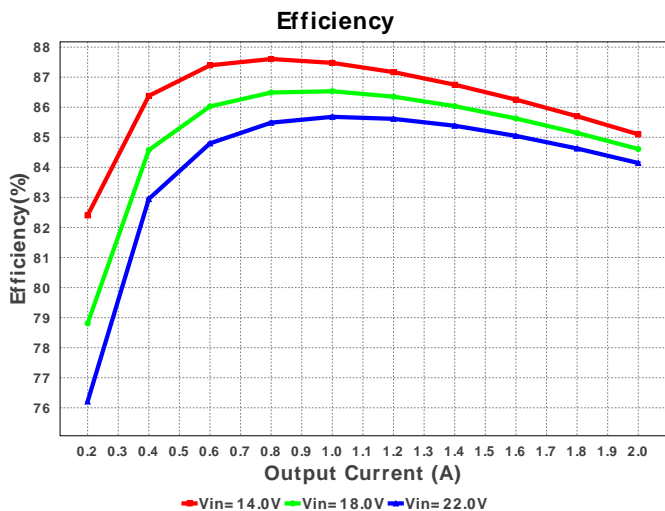
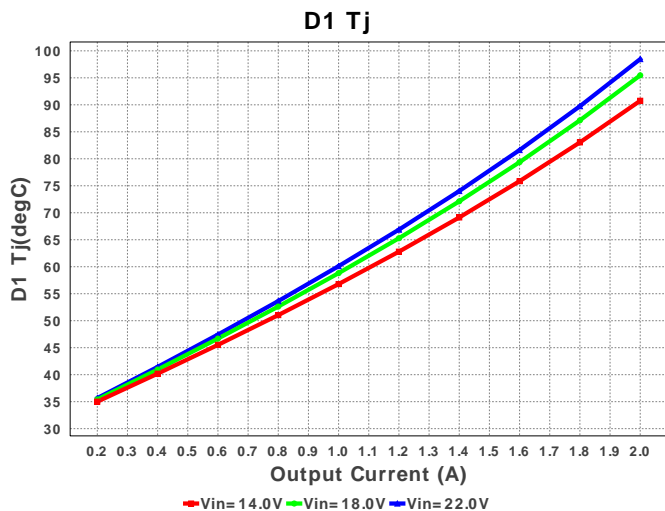
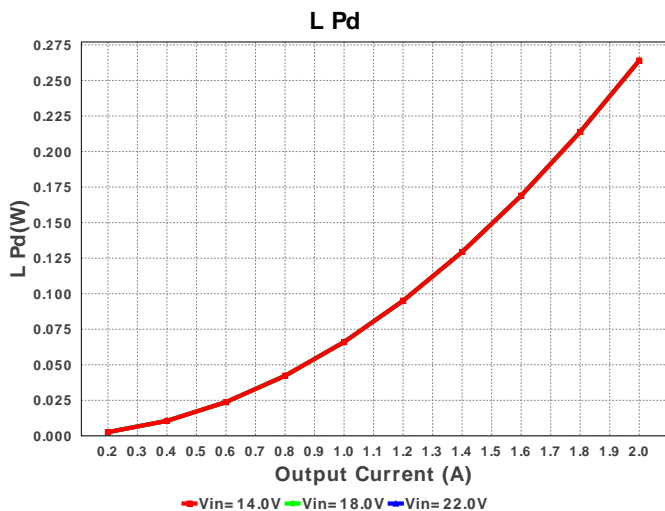

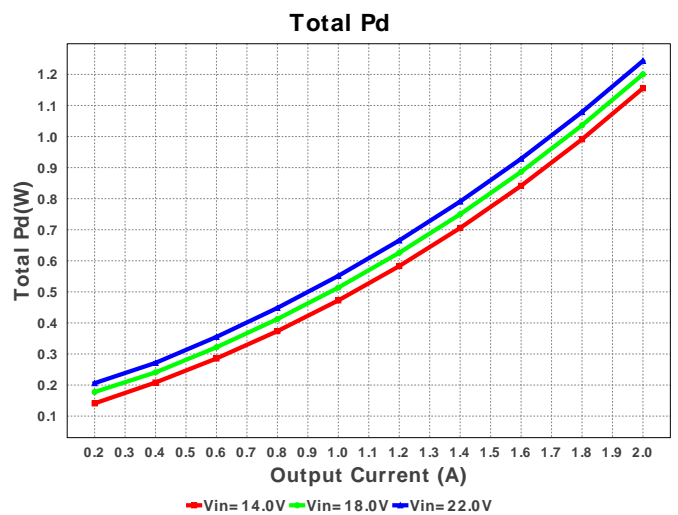
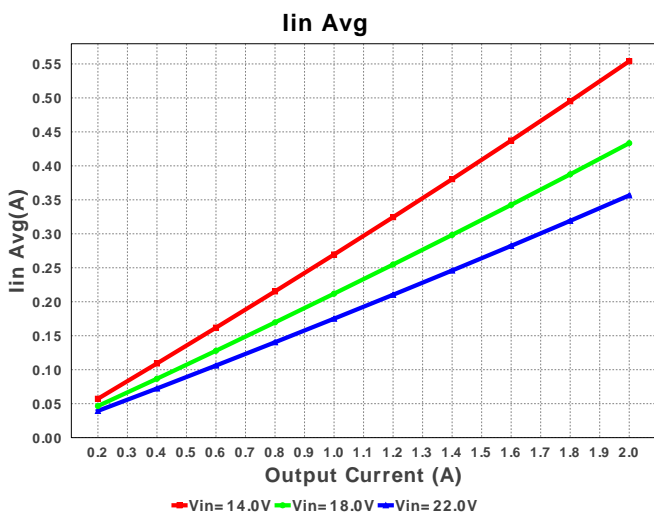
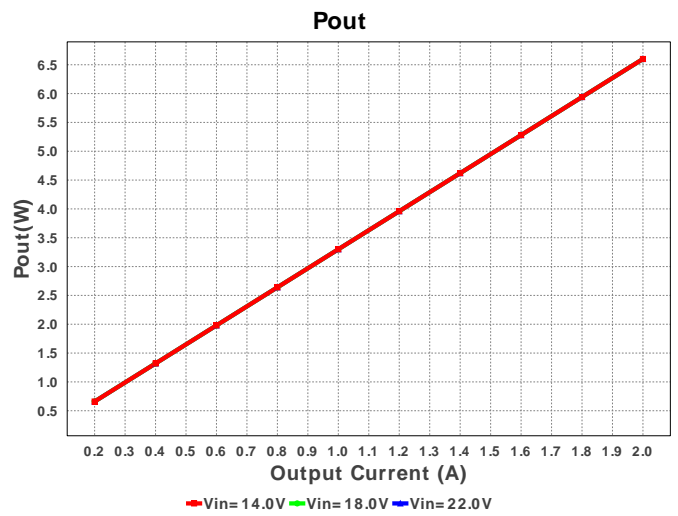
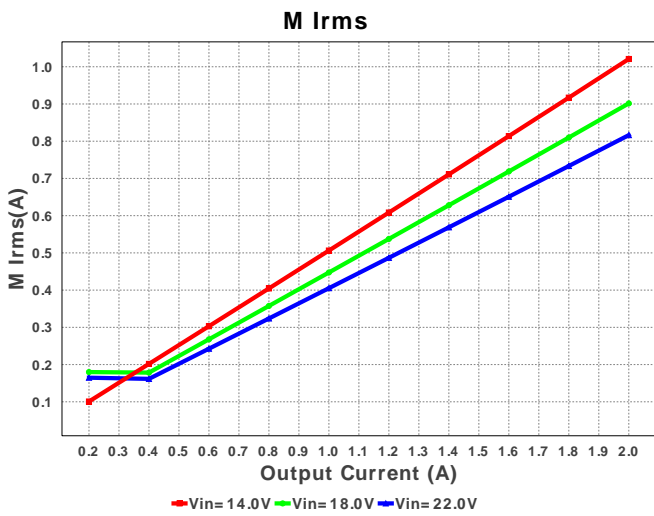
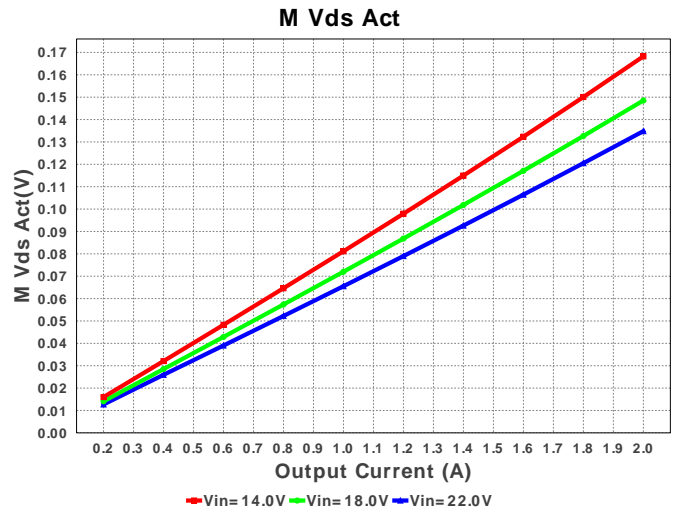
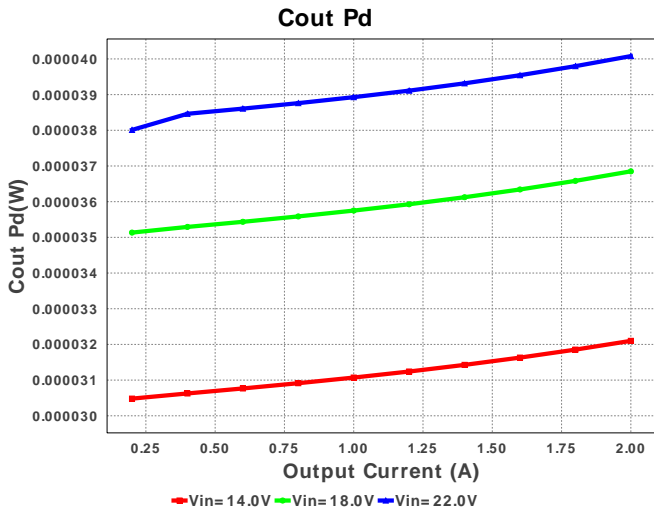



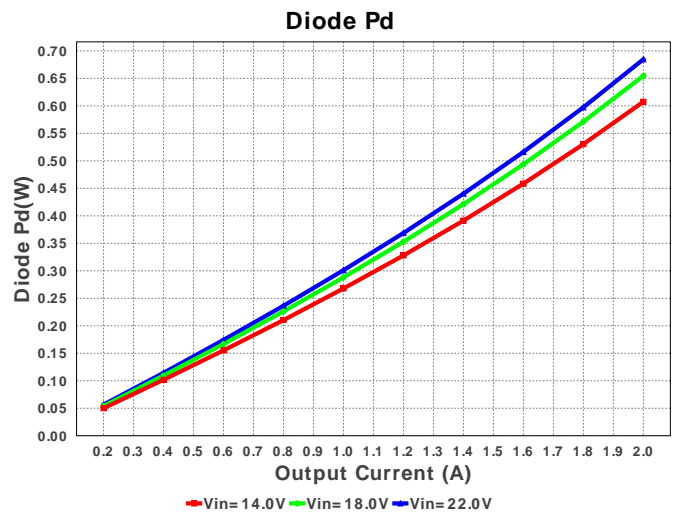
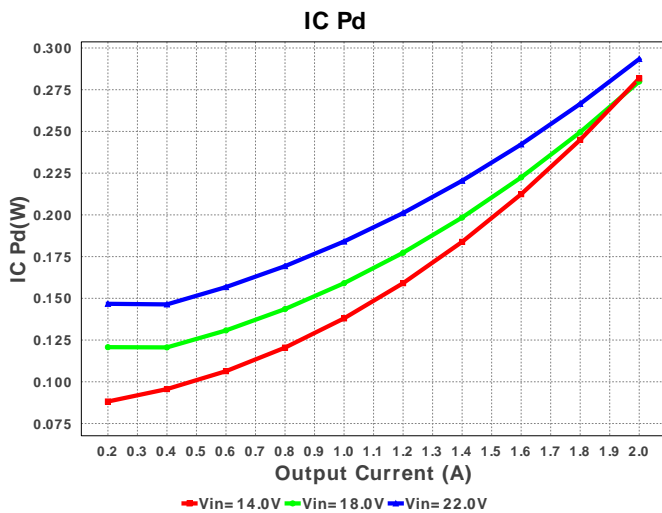
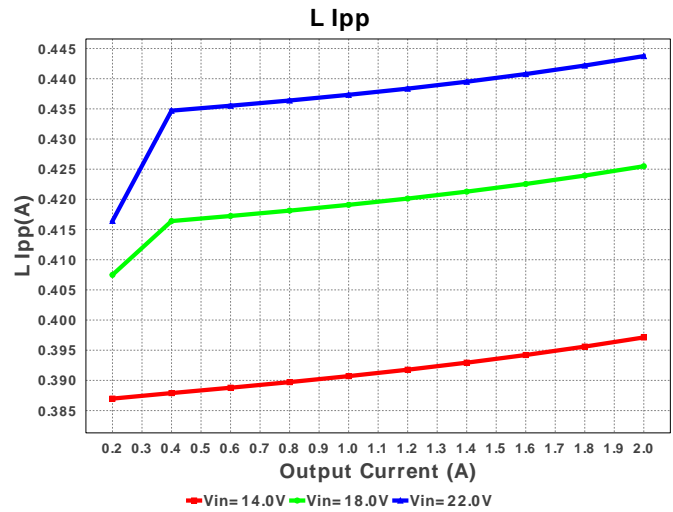
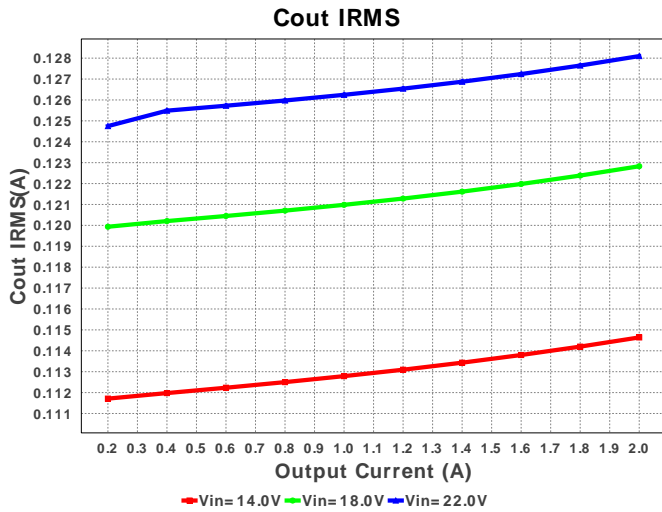

Operating Values

#	Name	Value	Category	Description
1.	Cin IRMS	702.231 mA	Current	Input capacitor RMS ripple current
2.	Cout IRMS	128.098 mA	Current	Output capacitor RMS ripple current
3.	IC Ipk	2.222 A	Current	Peak switch current in IC
4.	Iin Avg	356.53 mA	Current	Average input current
5.	L Ipp	443.74 mA	Current	Peak-to-peak inductor ripple current
6.	M Irms	816.289 mA	Current	MOSFET RMS current
7.	BOM Count	10	General	Total Design BOM count
8.	FootPrint	522.0 mm ²	General	Total Foot Print Area of BOM components
9.	Frequency	260.0 kHz	General	Switching frequency
10.	IC Tolerance	24.0 mV	General	IC Feedback Tolerance
11.	M Vds Act	134.814 mV	General	Voltage drop across the MosFET
12.	Pout	6.6 W	General	Total output power
13.	Total BOM	\$2.65	General	Total BOM Cost
14.	D1 Tj	98.47 degC	Op_Point	D1 junction temperature
15.	Vout Actual	3.315 V	Op_Point	Vout Actual calculated based on selected voltage divider resistors
16.	Vout OP	3.3 V	Op_Point	Operational Output Voltage
17.	Cross Freq	20.475 kHz	Op_point	Bode plot crossover frequency
18.	Duty Cycle	16.658 %	Op_point	Duty cycle
19.	Efficiency	84.145 %	Op_point	Steady state efficiency
20.	IC Tj	37.629 degC	Op_point	IC junction temperature
21.	ICThetaJA	26.0 degC/W	Op_point	IC junction-to-ambient thermal resistance
22.	IOUT_OP	2.0 A	Op_point	Iout operating point
23.	Phase Marg	42.717 deg	Op_point	Bode Plot Phase Margin
24.	VIN_OP	22.0 V	Op_point	Vin operating point
25.	Vout p-p	1.655 mV	Op_point	Peak-to-peak output ripple voltage
26.	Cin Pd	1.479 mW	Power	Input capacitor power dissipation
27.	Cout Pd	40.079 μW	Power	Output capacitor power dissipation
28.	Diode Pd	684.696 mW	Power	Diode power dissipation
29.	IC Pd	293.408 mW	Power	IC power dissipation
30.	L Pd	264.0 mW	Power	Inductor power dissipation
31.	Total Pd	1.244 W	Power	Total Power Dissipation

#	Name	Value	Category	Description
32.	Vout Tolerance	3.292 %		Vout Tolerance based on IC Tolerance (no load) and voltage divider resistors if applicable

Design Inputs

#	Name	Value	Description
1.	Iout	2.0	Maximum Output Current
2.	VinMax	22.0	Maximum input voltage
3.	VinMin	14.0	Minimum input voltage
4.	Vout	3.3	Output Voltage
5.	base_pn	LM2676	Texas Instruments Base Part Number
6.	source	DC	Input Source Type
7.	ta	30.0	Ambient temperature

Design Assistance

1. LM2676 Product Folder : <http://www.ti.com/product/LM2676> : contains the data sheet and other resources.

Texas Instruments' WEBENCH simulation tools attempt to recreate the performance of a substantially equivalent physical implementation of the design. Simulations are created using Texas Instruments' published specifications as well as the published specifications of other device manufacturers. While Texas Instruments does update this information periodically, this information may not be current at the time the simulation is built. Texas Instruments does not warrant the accuracy or completeness of the specifications or any information contained therein. Texas Instruments does not warrant that any designs or recommended parts will meet the specifications you entered, will be suitable for your application or fit for any particular purpose, or will operate as shown in the simulation in a physical implementation. Texas Instruments does not warrant that the designs are production worthy.

You should completely validate and test your design implementation to confirm the system functionality for your application prior to production.

Use of Texas Instruments' WEBENCH simulation tools is subject to [Texas Instruments' Site Terms and Conditions of Use](#). Prototype boards based on WEBENCH created designs are provided AS IS without warranty of any kind for evaluation and testing purposes and are subject to the terms of the [Evaluation License Agreement](#).